



Taking Shelter from the Storm

Building or Installing a Safe Room for Your Home

Includes Design Plans

FEMA P-320, March 2021

Fifth Edition



FEMA

Taking Shelter from the Storm

Building or Installing a Safe Room for Your Home

Includes Design Plans

FEMA P-320, March 2021
Fifth Edition



FEMA

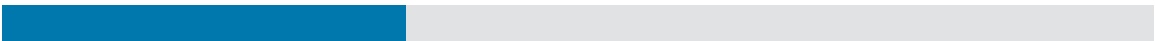

All illustrations in this document were created by FEMA or a FEMA contractor unless otherwise noted. All photographs in this document are public domain or taken by FEMA or a FEMA contractor unless otherwise noted.

Portions of this publication reproduce excerpts from the 2020 ICC/NSSA Standard for the Design and Construction of Storm Shelters (ICC 500), International Code Council, Inc., Washington, D.C.; www.iccsafe.org. Reproduced with permission. All rights reserved.

Any opinions, findings, conclusions, or recommendations expressed in this publication do not necessarily reflect the views of FEMA. Additionally, neither FEMA nor any of its employees make any warranty, expressed or implied, or assume any legal liability or responsibility for the accuracy, completeness, or usefulness of any information, product, or process included in this publication. Users of information contained in this publication assume all liability arising from such use.

All documents were prepared with accessibility and compliance with Section 508 of the Rehabilitation Act of 1973 in mind. For further information or clarification regarding items such as technical drawings or maps, please contact the FEMA Building Science Helpline at FEMA-BuildingScienceHelp@fema.dhs.gov or 866-927-2104.

Preface

Federal Emergency Management Agency (FEMA) publications presenting design and construction guidance for both residential and community safe rooms have been available since 1998. Since that time, tens of thousands of safe rooms have been built, and a growing number of these safe rooms have already saved lives in actual events. To date, FEMA has received no reported failures of a safe room constructed to FEMA criteria. Nevertheless, FEMA has modified its Funding Criteria as a result of post-disaster investigations into the performance of safe rooms and storm shelters after tornadoes and hurricanes. Further, FEMA's latest changes also consider the 2020 update to the consensus standard from the International Code Council® (ICC®) and the National Storm Shelter Association (NSSA®), the *ICC/NSSA Standard for the Design and Construction of Storm Shelters* (ICC 500).

This fifth edition of FEMA P-320 presents updated and refined criteria for residential safe rooms through reference to the newly updated fourth edition of FEMA P-361 (FEMA, 2021a), *Safe Rooms for Tornadoes and Hurricanes: Guidance for Community and Residential Safe Rooms*. FEMA P-320 draws on these updated criteria to address how to design and construct a safe room for a one- or two-family dwelling that provides near-absolute protection from wind and wind-borne debris for occupants. It should be noted that the updates in this edition of FEMA P-320 focus guidance exclusively on residential safe rooms for one- and two-family dwellings. Prescriptive safe room designs that meet FEMA criteria for one- and two-family dwellings are also included as a part of this publication. The 2021 editions of this publication and FEMA P-361 supersede the *FEMA National Performance Criteria for Tornado Shelters* (1999) as well as any earlier versions of FEMA P-320.

When safe room designers implement FEMA's safe room guidance in their projects, they can be confident they are using the best available information to guide the design and construction of a residential safe room. FEMA safe rooms provide near-absolute protection from the deadly winds and wind-borne debris associated with extreme-wind events.



Contents

Acronyms	iv
1. Introduction	1
2. Understanding the Hazards	6
2.1 Tornadoes	6
2.2 Hurricanes	9
2.3 Straight-Line Winds.....	12
2.4 Effects of Extreme Winds on a Building	13
2.5 Do You Need a Safe Room?.....	15
2.6 Assessing Your Risk	18
3. Planning Your Safe Room	20
3.1 Design Basis.....	20
3.2 Flood Hazard Siting and Elevation.....	21
3.2.1 Flood Hazard Siting Criteria.....	22
3.2.2 Flood Hazard Elevation Criteria	23
3.3 New versus Existing Homes	25
3.4 Safe Room Size	28
3.5 Safe Room Locations	28
3.5.1 Locating Your Safe Room: Above Ground or Below Ground?.....	28
3.5.2 Locating Your Safe Room: Inside or Outside?	29
3.5.3 Locating a Safe Room Inside a Home.....	30
3.6 Floor Plans Showing Possible Safe Room Locations	31
3.6.1 Floor Plan 1: Basement.....	31
3.6.2 Floor Plan 2: Safe Rooms on the Primary Level of a Home.....	32
3.6.3 Floor Plan 3: In-Ground Safe Rooms.....	33
3.6.4 Selection of Safe Room Type and Location.....	33
3.7 Foundation Type.....	35
3.7.1 Basement Foundation Applications: New Construction.....	35
3.7.2 Basement Foundation Applications: Existing Construction.....	36
3.7.3 Slab-on-Ground Applications: New and Existing Construction	37
3.7.4 Crawlspace or Pile Applications: New and Existing Construction	39
4. Consumer Guidance	41
4.1 Site-Built Safe Rooms.....	43
4.1.1 Construction Materials.....	43
4.1.2 Safe Room Door Assemblies	43
4.2 Prefabricated Safe Rooms.....	45

4.2.1	Testing and Labeling	45
4.2.2	Anchorage	46
4.3	Safe Room Cost.....	47
4.3.1	Safe Room Door Assembly Cost.....	47
4.3.2	Prefabricated Safe Rooms	48
4.3.3	FEMA Safe Room Funding	49
5.	Building Your Site-Built Safe Room	50
5.1	Design Plans Index.....	51
5.2	How to Use the Design Plans.....	52
5.2.1	Site Conditions Requiring Verification.....	54
5.2.2	Seismic Risks	55
5.3	Other Options.....	55
6.	Additional Resources, Emergency Planning and Supply Kit, and References	58
6.1	Additional Resources	58
6.2	Emergency Planning and Emergency Supply Kit	59
6.3	References	61
	Appendix A: Acknowledgments	63

List of Figures

Figure 2-1:	Typical tornado damage according to the EF Scale (wind speeds are estimated 3-second-gust wind speeds)	7
Figure 2-2:	Recorded EF3, EF4, and EF5 tornadoes in the United States from 1950 to 2018. Tracks are illustrative of path lengths, frequencies, and locations of extreme tornadoes; however, the widths of the track lines are greater than the widths of the areas prone to damaging winds (are not scaled).	8
Figure 2-3:	Typical damage associated with hurricane categories according to the Saffir-Simpson Hurricane Wind Scale (wind speeds are 1-minute sustained speeds)	10
Figure 2-4:	Major hurricane eye tracks along the United States and its territories from 1950 to 2019 providing an overview of the frequency and locations of hurricane strikes.....	11
Figure 2-5:	Storm surge.....	12
Figure 2-6:	Effect of extreme winds on building roof and walls	13
Figure 2-7:	Example of a garage door failure that likely initiated progressive failure, including loss of the garage roof (Joplin, MO; EF2 rating per MAT investigation).....	14
Figure 2-8:	Wind hazards in the United States	16
Figure 3-1:	Typical riverine cross section and coastal shoreline transect showing areas where residential safe room siting is acceptable or restricted	23
Figure 3-2:	The elevation of the safe room floor should be at or above the highest applicable flood elevation indicated.....	24
Figure 3-3:	Exterior walls constructed of CMU (New Smyrna Beach, FL, 2007)	26
Figure 3-4:	In-home safe room under construction; the CMU walls of the safe room are fully grouted and vertically reinforced with steel reinforcing bars from the foundation to the concrete roof deck (New Smyrna Beach, FL, 2007)	27
Figure 3-5:	An above-ground safe room constructed as an addition to a slab-on-ground home in a way that matches the aesthetics of the house (outside Tuscaloosa, AL, 2011).....	30

Figure 3-6: Above-ground residential safe room that was in the garage of a home hit by an EF5 tornado in Joplin, MO (2011).....	31
Figure 3-7: Floor Plan 1: Possible safe room locations in a basement.....	32
Figure 3-8: Floor Plan 2: Possible safe room locations for a house on a slab-on-ground or crawlspace foundation.....	32
Figure 3-9: Floor Plan 3: Possible in-ground safe room locations for a house without a basement.....	33
Figure 3-10: Appropriate types of safe rooms for new and existing homes.....	34
Figure 3-11: Cross section: Typical new construction basement foundation with safe room (reinforcement is shown for illustrative purposes only and will vary depending on safe room design).....	35
Figure 3-12: Cross section: Typical slab-on-ground foundation with safe room (reinforcement is shown for illustrative purposes only and will vary depending on safe room design).....	37
Figure 3-13: Cross-section: Typical crawlspace foundation with safe room (reinforcement is shown for illustrative purposes only and will vary depending on safe room design).....	39
Figure 4-1: Example door label for a product that has been tested to safe room criteria.....	45
Figure 5-1: Seismic Risk Map*	56

List of Tables

Table 2-1: Safe Room Risk Based on Location.....	18
Table 3-1: Construction, Applicability, and Access for Safe Rooms.....	34
Table 5-1: Design Plans Index	51

Acronyms

ACI	American Concrete Institute
AHJ	authority having jurisdiction
AMS	American Meteorological Society
ASCE	American Society of Civil Engineers
BRIC	Building Resilient Infrastructure and Communities
CMU	concrete masonry unit
DIs	Damage Indicators
DoDs	Degrees of Damage
EF Scale	Enhanced Fujita Scale
F Scale	Fujita Scale
FEMA	Federal Emergency Management Agency
FIRM	Flood Insurance Rate Map
FLASH	Federal Alliance for Safe Homes
HMA	Hazard Mitigation Assistance
HMGP	Hazard Mitigation Grant Program
IBC	International Building Code
ICC	International Code Council
ICF	insulated concrete form
IEBC	International Existing Building Code
IRC	International Residential Code
MAT	Mitigation Assessment Team
mph	miles per hour
NHC	National Hurricane Center
NOAA	National Oceanic and Atmospheric Administration
NSSA	National Storm Shelter Association
NSSL	National Severe Storms Laboratory
NWR	NOAA Weather Radio
NWS	National Weather Service
psf	pounds per square foot
RDP	registered design professional
SEI	Structural Engineering Institute
SFHA	Special Flood Hazard Area
SHMO	State Hazard Mitigation Officer



1

Introduction

Every year, tornadoes, hurricanes, and other extreme windstorms cause numerous injuries and deaths in the United States. While we cannot stop these storms from occurring, we can respond by understanding the hazards and carefully planning to protect ourselves from their effects. When properly designed and constructed or installed, safe rooms provide the highest level of protection from tornadoes, hurricanes, and other extreme windstorms.

FEMA P-320 SCOPE

This publication provides guidance from the Federal Emergency Management Agency (FEMA) about the planning, design, construction, and installation of residential safe rooms. It presents important information about aspects that will protect people during extreme-wind events such as tornadoes and hurricanes. This publication also includes safe room designs you and your builder/contractor can use as a starting point to construct or install a safe room for your home. Design options include safe rooms located inside or outside of a new home. Guidance is also provided on how to modify your home to add a safe room in an existing space. The safe rooms discussed herein are designed to protect you and your family from the extreme winds expected during tornadoes and hurricanes and from wind-borne debris associated with these events.

This guidance in FEMA P-320 is primarily intended for homeowners, builders, and contractors, but can also be used by design professionals and local officials for decision-making guidance on residential tornado and hurricane safe rooms. Design professionals and other readers seeking more technical guidance should refer to FEMA P-361, *Safe Rooms for Tornadoes and Hurricanes: Guidance for Community and Residential Safe Rooms* (FEMA, 2021a), which contains the design criteria and commentary used to develop the prescriptive solutions and safe

FEMA P-320 UPDATED SCOPE

Updates in this edition of FEMA P-320 focus guidance exclusively on residential safe rooms for one- and two-family dwellings. While the prescriptive solutions in this publication may be used as a starting point for a small community safe room, FEMA recommends that registered design professionals (RDPs) consult FEMA P-361 (FEMA, 2021a) for guidance on all community safe room projects.

FEMA P-320 AND FEMA P-361

The design criteria for all safe rooms are provided in Part B of FEMA P-361 (FEMA, 2021a), which also includes commentary for safe room designers. FEMA P-320 includes the prescriptive design plans for site-built safe rooms that were developed using the design criteria provided in FEMA P-361.

room planning guidance in this publication. The safe room designs in this publication were developed primarily for use in new one- and two-family dwellings, but some can be used in existing houses. **The 2021 editions of this publication and FEMA P-361 supersede the *FEMA National Performance Criteria for Tornado Shelters* (1999) as well as any earlier versions of FEMA P-320 and FEMA P-361.**

In August 2008, the International Code Council (ICC), with the support of the National Storm Shelter Association (NSSA), released a consensus standard on the design and construction of storm shelters. This standard, the *ICC/NSSA Standard for the Design and Construction of Storm Shelters* (ICC 500), codifies much of the safe room recommendations of the early editions of FEMA P-361. The second edition of ICC 500 was published in 2014, and the third edition in 2020. Unless noted otherwise, the guidance in this publication is based on ICC 500-2020 (third edition). ICC 500 provides the minimum design

and construction requirements for extreme-wind storm shelters and has been incorporated by reference as a standard to be followed for storm shelter design and construction in the 2009, 2012, 2015, 2018, and 2021 International Building Code (IBC) and International Residential Code (IRC), as well as the 2018 and 2021 International Existing Building Code (IEBC). Those involved in the design, construction, and maintenance of safe rooms should become knowledgeable about both FEMA guidance and ICC code and standard requirements that pertain to sheltering from extreme winds. Knowledge of the information in these publications will help those involved navigate local applicable codes, employ best practices to provide near-absolute protection, and apply for FEMA funds that may be available (if desired).

A safe room for your home can provide near-absolute protection for you and your family from injury or death resulting from the dangerous effects of extreme winds. Near-absolute protection means that, based on our current knowledge of tornadoes and hurricanes, the occupants of a safe room designed and constructed or installed according to this publication (and FEMA P-361 [FEMA, 2021a]) will have a high probability of being protected from injury or death during a storm. Our knowledge of tornadoes and hurricanes is based on substantial historical meteorological records as well as extensive post-storm assessments of damage to structures from extreme winds and flood. Having a safe room can also relieve some of the anxiety created by the threat of an oncoming tornado or hurricane. Having a storm shelter has also been shown to increase the sales price of a house by about 3.5 percent (representing about \$4,200 for a typical home in the study group¹), as safety is a desired attribute for housing.

1 Statistics from a presentation titled, "Disaster Mitigation," about a National Science Foundation-funded hurricane market mitigation study; the presentation by Kevin M. Simmonds, PhD, is located online at https://en.vedur.is/media/loftslag/FMI_-_Disaster_Mitigation.pdf. The presentation references the publication titled, *Economical and Societal Impacts of Tornadoes* (Simmonds and Sutter, 2010).

Should you consider building a safe room in your home to protect you and your family during a tornado or hurricane?

This publication will help you answer this and other important questions so you can decide how best to provide that protection. It includes the results of research that has been underway for 50 years, lessons learned from thousands of observations made by FEMA’s Mitigation Assessment Team (MAT) following high-wind events, and other wind engineering research on the effects of extreme winds on buildings. For more information on FEMA’s MAT Program, refer to the “FEMA’s MAT Program” textbox at the end of this chapter.

TERMINOLOGY

Residential safe room. A safe room serving occupants of dwelling units and having a design occupant capacity not exceeding 16 persons.

Community safe room. Any safe room not defined as a residential safe room. A community safe room can be open to the general public, or for a specific set of intended occupants.

Registered design professional (RDP). A registered design professional, which hereafter is abbreviated “RDP,” is a licensed professional engineer or a licensed registered architect. These individuals must meet the respective statutory requirements of the professional registration laws of the state or jurisdiction where the project will be constructed.

SAFE ROOM VERSUS STORM SHELTER

Though similar, there are important differences between safe rooms and storm shelters. While both must meet all ICC 500-2020 requirements, safe rooms also meet the FEMA Funding Criteria for safe rooms described in FEMA P-361, *Safe Rooms for Tornadoes and Hurricanes: Guidance for Community and Residential Safe Rooms* (FEMA, 2021a); these criteria are more conservative than those presented in ICC 500 for storm shelters.

The most substantial differences between residential storm shelter and safe room criteria involve siting and elevation requirements for flood-prone areas and FEMA’s Funding Criterion that residential safe rooms meet or exceed the highest tornado storm shelter

and safe room design mapped windspeed (250 mph) regardless of mapped location. All differences between ICC 500 and FEMA Funding Criteria are explained at the beginning of each FEMA P-361 (FEMA, 2021a) Part B chapter and are summarized in Appendix D of that document.

If a safe room will be constructed with FEMA grant funds, the FEMA Funding Criteria become requirements, in addition to the requirements for storm shelters in ICC 500. Although not required, a best practice is to apply FEMA safe room guidance to the design and construction of all storm shelters, even those that are not constructed with FEMA grant funds.

The safe room designs provided in this publication have been designed with life-safety protection as the primary consideration. They are a set of “prescriptive solutions” to the technical design criteria set forth in ICC 500 and FEMA P-361. When site conditions and foundation requirements are addressed by a registered design professional (RDP), these designs will meet or exceed the design requirements set forth in ICC 500 and FEMA P-361 for residential storm shelters for both tornado and hurricane hazards. The safe room designs presented herein provide options for site-built solutions; information on prefabricated safe rooms can be found in Section 4.2 of this publication.

FEMA'S MAT PROGRAM

The Federal Emergency Management Agency (FEMA) carries out many actions in response to a natural disaster. When a Presidential Disaster Declaration is made and a state, tribe, or territory requests an investigation, FEMA may deploy a Mitigation Assessment Team (MAT) to the location impacted by the natural disaster. A MAT conducts performance assessments of buildings and related infrastructure to determine both the causes of damage and performance of past mitigation efforts and projects. The MAT then recommends actions that federal, state, and local governments; building officials; floodplain administrators and regulators; the design and construction industry; building code and standard organizations; academia; emergency managers; building owners and operators; or other stakeholders can take to mitigate damage from future natural hazard events. Furthermore, the recommendations resulting from a MAT help FEMA coordinate with agencies and organizations to assess the hazard-resistance provisions of building codes and standards. Long-term strategies can then be developed to help reduce future damage and impacts from a variety of natural hazard events and improve community resilience.

Oftentimes, shelter-related recommendations are made by a MAT, such as those made by the team that investigated the April 25–28, 2011, tornado outbreak in Alabama, Mississippi, Georgia, and Tennessee and the May 22, 2011, tornado in Joplin, MO. Following their investigation, FEMA P-908, *Mitigation Assessment Team Report: Spring 2011 Tornadoes* (FEMA, 2012), was published with the MAT's observations and 49 recommendations. Lessons learned from this MAT also helped to inform the updates to the previous edition of FEMA P-320 and FEMA P-361, along with ICC 500-2014 and the 2015 IBC.



The 2017 hurricane season was extremely active, producing 17 named storms. Six of these storms became major hurricanes (Category 3, 4, or 5), and three ranked in the National Hurricane Center's (NHC's) top five hurricanes with the greatest cumulative damage (NOAA NHC, 2018). FEMA deployed four MATs, which resulted in four MAT reports and many other products, including 16 Recovery Advisories and multiple training efforts. The 2017 *Hurricane Season Mitigation Assessment Team Compendium Report* (FEMA P-2054) summarizes these and includes links to the 2017 MAT products. It is available at <https://www.fema.gov/emergency-managers/risk-management/building-science/mitigation-assessment-team>. Each of these reports has helped to inform best practices, as well as the need for safe rooms. Several recommendations are directly related to safe rooms.

For more information on FEMA's MAT and to access MAT publications, visit <https://www.fema.gov/mitigation-assessment-team-program>.

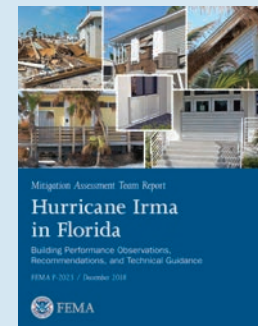
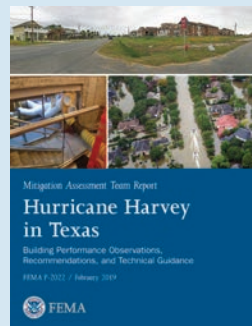
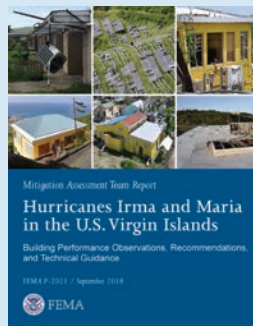
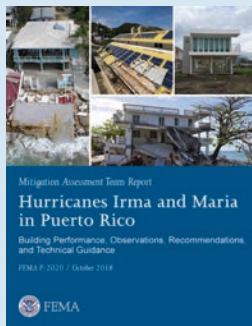

TORNADO OCCURRENCE AND RESULTANT LOSSES

The National Weather Service (NWS) did not start keeping organized records of tornadoes in the United States until 1950. Since then, the deadliest year for tornadoes was 2011, in which 553 lives were lost. The single deadliest tornado to date was in Joplin, MO, on May 22, 2011, with 161 fatalities.

Compared with other natural hazards, single tornado events typically affect smaller geographical areas but occur more often and cause more deaths than hurricanes and earthquakes. From 1950 through 2019, tornadoes caused about 5,900 fatalities in the United States (NIST, 2014 and NOAA, 2020).



Above-ground shelter that performed well in a heavily damaged area (Oklahoma City, OK, 2013)



2

Understanding the Hazards

Every state in the United States has been affected by extreme windstorms such as tornadoes, hurricanes, and straight-line winds. In fact, all states have been impacted by tornadoes, and all Atlantic and Gulf of Mexico coastal areas of the United States, plus Puerto Rico, the U.S. Virgin Islands, Guam, the Mariana Islands, American Samoa, and Hawaii, have been affected by hurricanes. Even states not normally considered to be susceptible to extreme windstorms have experienced dangerous extreme winds; areas that are lesser known for experiencing extreme winds are typically near mountain ranges, including the Pacific Northwest coast and coastal Alaska including its archipelago.

A homeowner's decision regarding whether to build a safe room depends in large part on the risk of being struck by one of these events. This chapter describes tornadoes, hurricanes, the effect of high winds on a building, and the decision process for determining the need for a safe room.

2.1 Tornadoes

A tornado is a violently rotating column of air with wind speeds that can be significantly higher than design wind speeds in modern building codes. Although tornadoes typically occur in the spring and summer months, they can occur at any time in most parts of the country. In some cases, hurricanes spawn tornadoes. The severity of a tornado is categorized by the Enhanced Fujita Scale (EF Scale; see Figure 2-1). The National Oceanic and Atmospheric Administration (NOAA) adopted the EF Scale to replace the Fujita Scale (F Scale) in February 2007. The EF Scale is similar to the F Scale but has a greater number of Damage Indicators (DIs) and refined wind speed estimates. DIs, along with their associated Degrees of Damage (DoDs), are used to characterize the observed damage experienced by buildings during a tornado. This observed damage is then linked to an estimated wind speed range likely to have caused that level of damage and allows an EF rating to be assigned to the overall tornado. Currently, the EF Scale is being further refined and expanded by the American Society of Civil Engineers (ASCE)/ Structural Engineering Institute (SEI) / American Meteorological Society (AMS) through development of the *Wind Speed Estimation in Tornadoes* standard. More information on the standard is available in Section A2.1 of FEMA P-361 (FEMA, 2021a).

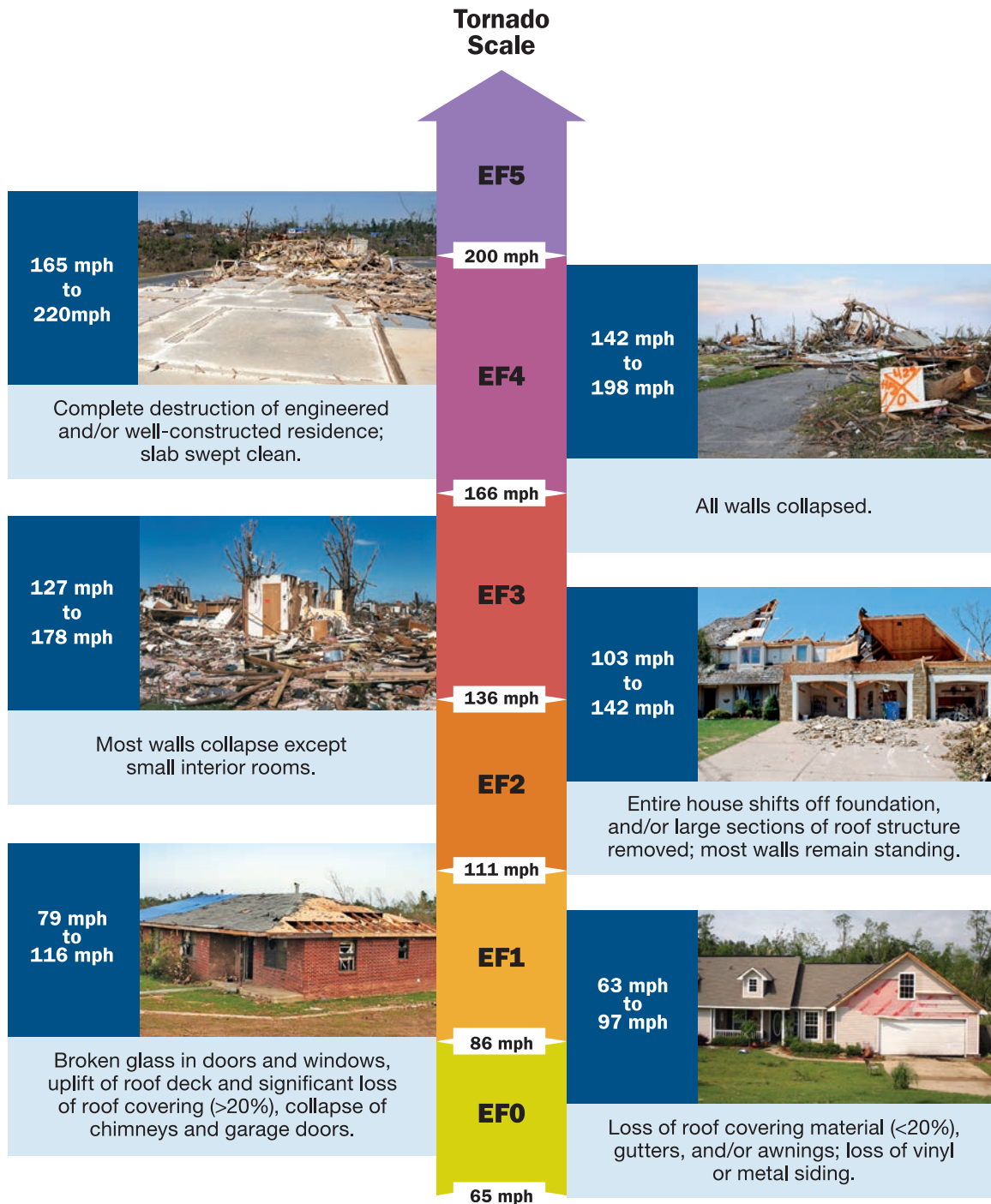

Figure 2-1: Typical tornado damage according to the EF Scale (wind speeds are estimated 3-second-gust wind speeds)

SOURCE OF DATA: NOAA NATIONAL WEATHER SERVICE, STORM PREDICTION CENTER

The probability of occurrence of tornadoes varies across the country and within each state. Comparing the numbers of tornadoes recorded in different areas of the country can give you a better understanding of potential tornado activity in those areas. Figure 2-2 shows the general locations of recorded EF3, EF4, and EF5 tornadoes in the United States between 1950 and 2018 (NOAA NCEI, Undated and NOAA National Weather Service Storm Prediction Center,

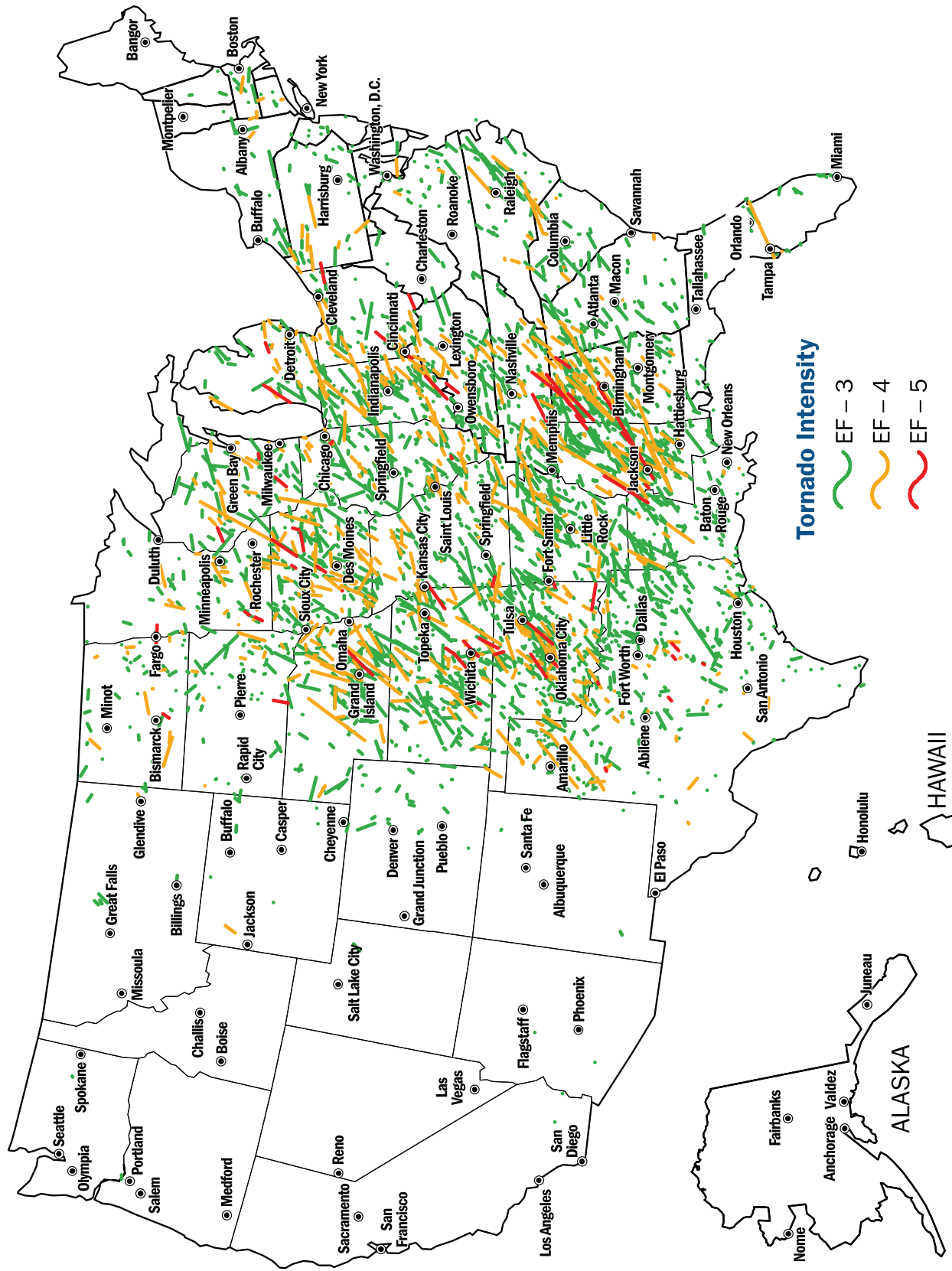

Figure 2-2: Recorded EF3, EF4, and EF5 tornadoes in the United States from 1950 to 2018. Tracks are illustrative of path lengths, frequencies, and locations of extreme tornadoes; however, the widths of the track lines are greater than the widths of the areas prone to damaging winds (are not scaled).

SOURCE: NOAA NATIONAL WEATHER SERVICE, STORM PREDICTION CENTER

Undated). While this map presents a reasonable portrayal of tornado activity in the United States since 1950, it should not be assumed that locations that do not have a tornado track marked have never had a tornado or will never experience one. First, any tornadoes that occurred prior to 1950 are not shown on this map. Second, EF3 through EF5 tornadoes represent less than approximately 5.5 percent of the tornadoes that occur, since most are weaker (EF0 through EF2) tornadoes. Third, it is likely that some tornadoes went undetected, and therefore unrecorded, and consequently are not shown on this map. And lastly, if a tornado is not shown in a particular location on this map, it does not suggest that a tornado will never occur in those locations; a tornado can occur anywhere, given the appropriate conditions.

It should be noted that flash flooding can and does happen simultaneously with a tornado (Nielsen et al., 2015). On May 31, 2013, one such event occurred in Oklahoma City, OK. Thirteen deaths were associated with the flash flooding, whereas eight deaths were directly associated with the tornado. Per a paper published in 2015, members of the public who were interviewed seemed to have no knowledge of the flash flooding threat despite National Weather Service warnings, which were also posted on social media platforms (Nielsen et al., 2015). In May 2015, a woman in Oklahoma drowned as a result of flash flooding while seeking shelter from a tornado in a below-ground storm cellar (KWTV, as cited in Nielsen et al., 2015). Incidents like this illustrate why proper siting of a safe room with respect to flood hazard is crucial (see Section 3.2).

2.2 Hurricanes

A hurricane is a tropical cyclone with sustained winds of 74 mph or greater. Hurricanes are characterized by a low-pressure center that creates strong winds and rain. Hurricane intensities depend on a number of complex processes, but are generally measured in terms of maximum surface wind speeds or minimum surface pressure. Hurricanes are categorized by the Saffir-Simpson Hurricane Wind Scale (see Figure 2-3), which assigns a category from 1 to 5 based on a hurricane's sustained wind speed. Hurricanes can be devastating storms; while tornadoes affect smaller areas, hurricanes are broad storms capable of delivering high winds and flooding, including storm surge, to large areas. A hurricane that reaches Category 3 or higher is considered a major hurricane, but Category 1 and 2 hurricanes are still dangerous and can cause the same levels of flooding as major hurricanes.

NOAA maintains a hurricane database associated with a tool that maps previous hurricane tracks (i.e., the National Climatic Data Center Storm Events Database). Records for the Atlantic Basin extend as far back as 1851. Hurricanes have made landfall in Florida more than in any other state. The second most hurricane-affected state is Texas, but every state on the Gulf Coast and bordering the Atlantic Ocean is susceptible to damage caused by hurricanes, as are U.S. island territories, which have been seriously affected by numerous hurricanes and tropical cyclones. While Alaska is not subject to hurricanes, it is subject to design-level coastal high winds that rival hurricane design winds for much of Florida. Hurricanes between 1950 and 2019 resulted in 3,146 deaths (NOAA, 2020).

Figure 2-4 shows the tracks of major hurricane eyes from 1950 to 2019, both right off the coast and those that made landfall in the United States and its territories. This figure provides an overview of frequency and locations of hurricane strikes; however, it underrepresents the areas affected by wind hazard for any given event by only indicating the path of the storm's eye. While the area affected by any landfalling hurricane varies significantly, the inset of Figure 2-4 demonstrates the large area affected by a single event, Hurricane Michael (2018).

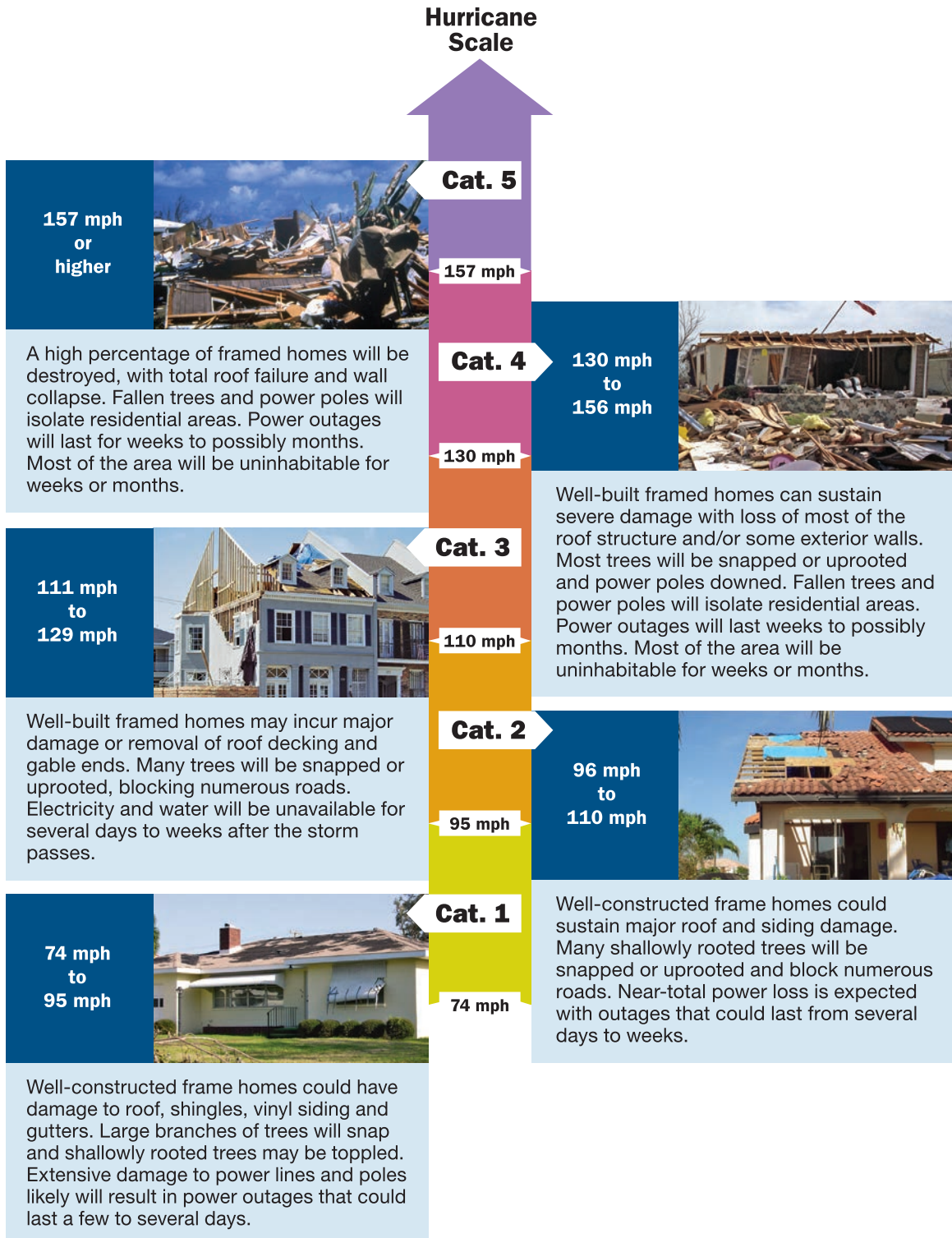

Figure 2-3: Typical damage associated with hurricane categories according to the Saffir-Simpson Hurricane Wind Scale (wind speeds are 1-minute sustained speeds)

SOURCE: NOAA NATIONAL WEATHER SERVICE, NATIONAL HURRICANE CENTER

While the Saffir-Simpson Hurricane Wind Scale is no longer associated with storm surge depths (since 2010), storm surge is a very dangerous effect of hurricanes (see Figure 2-5). Furthermore, slow-moving hurricanes and even tropical storms have often been accompanied by so much rainfall that they produce significant flooding of low-lying areas, waterways, and drainage basins. Several recent hurricanes have caused record flooding. When considering a safe room, the potential for flooding and storm surge needs to be determined, and siting and elevation may need to be adjusted accordingly.

WARNING!

SAFE ROOMS IN AREAS LIKELY TO FLOOD

Safe rooms designed to protect you and your family from a hurricane or tornado *should not* be built in areas expected to be flooded during a hurricane, thunderstorm, or other severe weather event. Residents of hazard-prone coastal areas should abide by the warnings of their state and local officials and evacuate to safer ground. The protection from wind provided by safe rooms and storm shelters is quickly negated when people find themselves trapped and inundated by floodwater.

If you do not know whether your home is in a storm surge area or other area that is likely to flood, ask your local emergency management, floodplain management, or building official.

TERMINOLOGY

Storm surge. In this publication, “storm surge” means an abnormal rise in sea level accompanying a hurricane or other intense storm, with a height that is the difference between the observed level of the sea surface and the level that that is normally observed in the absence of the tropical cyclone. Storm surge (see Figure 2-5) is usually estimated by subtracting the normal or predicted astronomical tide from the observed storm tide.

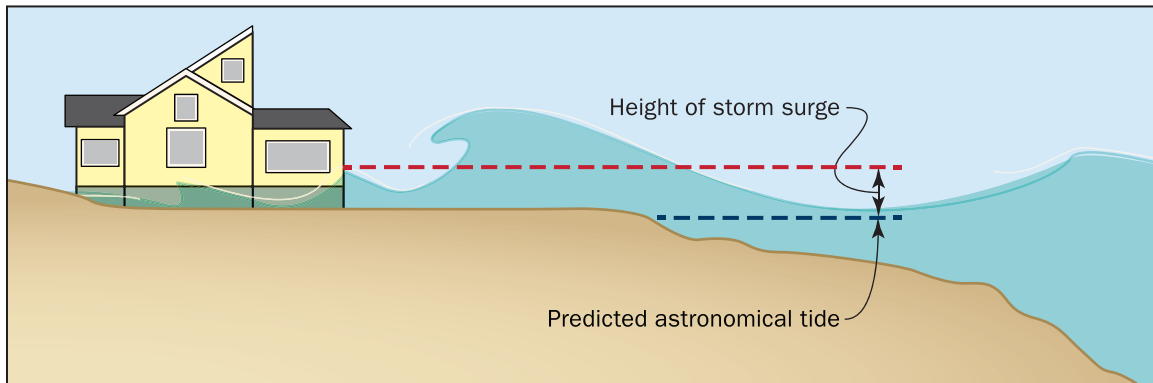

Figure 2-5: Storm surge

2.3 Straight-Line Winds

According to NOAA’s National Severe Storms Laboratory (NSSL), damaging winds (also called “straight-line winds” to distinguish them from tornadoes) are classified as those exceeding 50 to 60 mph and are generally the result of outflow generated by a thunderstorm downdraft. However, there are several other meteorological processes during a thunderstorm that can result in straight-line winds. Straight-line winds can happen anywhere a thunderstorm can happen. Per the NSSL, “damage from severe thunderstorm winds account for half of all severe weather reports in the lower 48 states and is more common than damage from tornadoes. Wind speeds can reach up to 100 mph and can produce a damage path extending for hundreds of miles” (<https://www.nssl.noaa.gov/education/svrwx101/wind/>). Straight-line winds can cause severe injury or death.

2.4 Effects of Extreme Winds on a Building

Extreme winds can cause severe damage to a building. For example, the roof covering, roof deck, or wall siding can be pulled off, and the windows can be pushed in or pulled out from the walls or shattered. Figure 2-6 shows how extreme winds can affect a building and cause it to fail. When wind enters a building through a broken window, door, or roof section, that wind acts on the inside of a building much like air acts when forced into a balloon; it pushes on the walls and roof of the building from the inside. These forces within the building added to the wind forces acting on the outside of the building often result in the failure of a building and/or building component. While buildings are designed for a minimal amount of internal pressure added to external pressures, they are not designed to resist the significantly higher internal pressures that can result from a broken window, door, or roof section. Recognition of this effect led to requirements for impact protection of windows and doors in hurricane-prone regions.

Within the vortex of a tornado or the eye of a hurricane, it has been well established that decreases in atmospheric pressure (a decrease of 100 pounds per square foot [psf] or more) can be as large or larger than the wind-induced pressures on the exterior of a building. In hurricanes, this change occurs relatively slowly due to the storm's size and relatively slow motion. Consequently, the air leakage in most buildings will tend to equalize the atmospheric pressure inside the building with that outside the building, preventing a large atmospheric pressure drop that would create significant loads on the building. However, due to a tornado's relatively small size and high translational speeds, the core of a tornado passing over a well-sealed building can quickly cause a large drop in atmospheric pressure, significantly increasing loads on the building.

In the early years of post-tornado investigations, observations often appeared to suggest that a building impacted by a strong tornado exploded. This gave rise to the misconception that windows and doors in a building should be opened when a tornado was forecasted in order to equalize the internal and external pressures on the building. However, more in-depth post-storm investigations found that the roof was typically lifted off the walls and that sidewalls and the

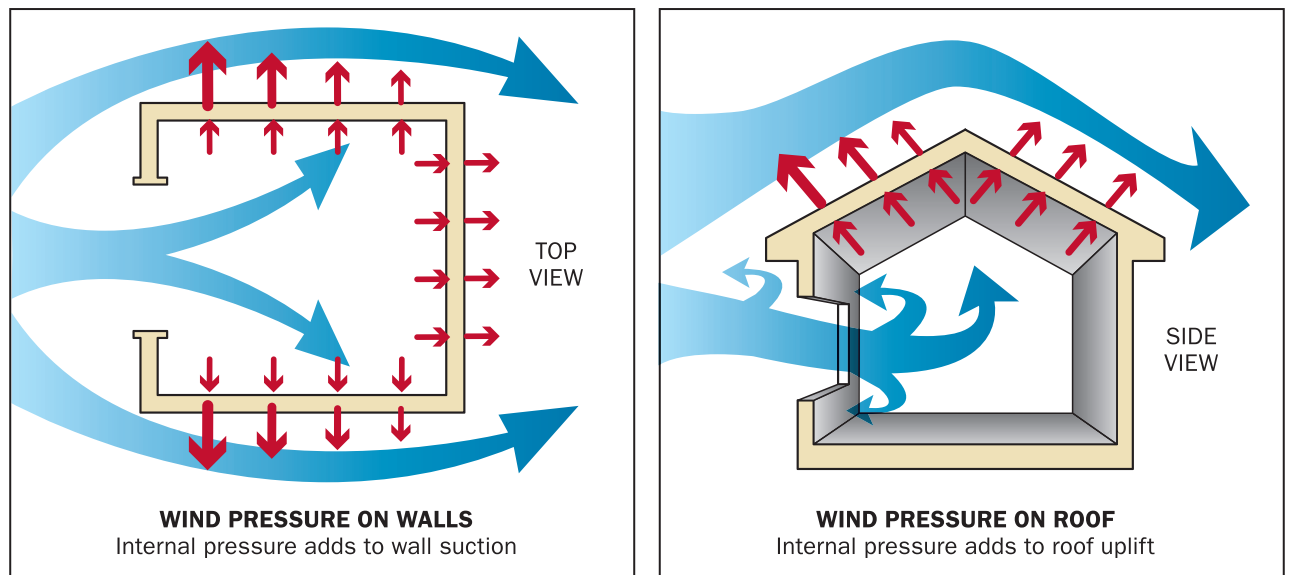

Figure 2-6: Effect of extreme winds on building roof and walls

back wall were blown outward while the windward wall was blown inward. These observations suggested mechanisms more consistent with direct wind loading augmented by an increase in internal pressure from either broken windows or doors on the windward face or a drop in atmospheric pressure that was not equalized by air leakage or the failed windows and doors. Failure of protection over large openings, such as one or more garage doors, can allow so much wind to enter the building that open windows would not provide enough relief to prevent internal pressure increases. This is illustrated in Figure 2-7, where the failure of a garage door initiated progressive failure that included the loss of the garage roof.

The design loads used for safe rooms in this guide, as well as for tornado storm shelters in ICC 500, include allowances for pressure differences that can occur due to atmospheric pressure drop outside the storm shelter that is not fully equalized by corresponding internal pressure changes.

Figure 2-7: Example of a garage door failure that likely initiated progressive failure, including loss of the garage roof (Joplin, MO; EF2 rating per MAT investigation)



In addition to the damage from wind pressures from a tornado, damage can also be inflicted by wind-borne debris. If wind speeds are extreme, debris can penetrate or perforate windows, doors, walls, or the roof. For example, a 2x4 wood stud weighing 15 pounds, when carried by a 250 mph wind, can have a horizontal speed of 100 mph, which is enough force to penetrate or perforate most common building materials used in homes today. Even a reinforced masonry wall, which typically has hollow cells between reinforced cells, will be perforated unless it has been designed and constructed to resist debris impact during extreme winds. Because debris can severely damage and even puncture windows, doors, walls, and roofs, it threatens not only buildings, but the occupants as well. This is another reason to seek refuge in the safest area available in the building as quickly as possible. However, note that just because an area is deemed the safest in the building, it does not guarantee your safety; the only way to provide life safety protection from a tornado is to build an ICC 500-compliant storm shelter or FEMA P-361-compliant safe room.

TERMINOLOGY

Missile. A 2x4 wood stud used to simulate wind-borne debris for impact resistance testing of safe rooms.

Wind-borne debris. Debris that is picked up by the wind and moved with enough force to damage and even penetrate roofs, windows, doors, walls, and other parts of a building. In general, the stronger the wind, the larger and heavier the debris it can carry and the greater the risk of severe damage or injury. But even small stones, branches, and other lighter debris can easily break glass doors and windows.

2.5 Do You Need a Safe Room?

Homeowners should ask themselves several questions when considering whether to construct or install a safe room:

- What is my risk of tornadoes or hurricanes?
- What existing refuge options do I have if a tornado or hurricane occurs in my location? What if straight-line winds occur?
- Am I willing to accept my property-specific extreme-wind risk without having a safe room?
- How feasible is it to construct or install a safe room, and what are the costs?

On the basis of 70 years of tornado history and more than 160 years of hurricane history, the United States has been divided roughly into four zones that geographically reflect the number and strength of recorded tornadoes (Figure 2-8). Zone IV has experienced the most and the strongest tornado activity. Zone III has experienced significant tornado activity and includes most coastal areas that are also susceptible to tornadoes spawned from hurricanes. Zones II and I represent areas with relatively lower historical tornado activity that correlates with a lower risk of tornadoes in those areas. Zone II includes some areas east of the Rocky Mountains that are not covered in Zone III and parts of the Northeast. Zone I primarily consists of areas west of the Rocky Mountains, where there are relatively few tornado occurrences.

The United States hurricane-prone region includes areas along the Gulf and Atlantic Coasts, and also covers Hawaii and U.S. island territories in the Caribbean and South Pacific. The location of the hurricane-prone region within the continental United States is based on information from all recorded hurricanes dating from 1851. Additionally, non-hurricane coastal high-wind events occur in Alaska. The hurricane-prone regions and coastal high-wind region (Alaska only) shown in Figure 2-8 represent areas at substantial risk to hurricanes and other coastal high-wind events.

Section 2.6 includes guidance to help you determine your level of risk from these extreme events and will

EVACUATION CONSIDERATIONS

Even if a safe room is designed and constructed or installed to meet all applicable FEMA criteria, the use of the safe room during an emergency event may not be in compliance with mandatory evacuation orders of the local jurisdiction. For instance, local emergency management officials may declare a mandatory evacuation prior to a hurricane event. FEMA recommends that all potential safe room occupants comply with local jurisdictional directions and evacuation orders during an emergency event even if they have access to a safe room.

Evacuation options are very limited for island populations with no vehicular access to the U.S. mainland, but may include orders to shelter outside of areas subject to storm surge inundation during hurricanes. With fewer options available, it is especially critical to plan for your safety. When installing a safe room in your home is not feasible because of flood siting restrictions, foundation type, or other reason, FEMA recommends that you find a community safe room that will be accessible to you and your family. Where no community safe rooms are available, sheltering in Best Available Refuge Areas is recommended. For more information on Best Available Refuge Areas, please refer to Section A2.1.2 of FEMA P-361 (FEMA, 2021a). See also Section 6.1, Additional Resources, in this publication for more information on hurricane preparedness.

help you decide whether to construct or install a safe room. If you decide that you need a safe room, Chapter 3 will help you and your builder/contractor or RDP plan your safe room. To learn more about the occurrence of high-wind events for the area where you live, check with your meteorologist or local emergency management official. Also, visit the NOAA National Climatic Data Center, which contains data on various types of storms within the United States, at <http://www.ncdc.noaa.gov/stormevents>.

The prescriptive designs included in this publication should not be used to construct or install safe rooms in hurricane-prone areas that may be inundated by storm surge or flooding from a hurricane. If FEMA funding is being used to design and construct a residential safe room, it cannot be constructed in a storm surge inundation area for any modeled storm. In areas not prone to storm surge, a safe room may be installed within mapped floodplains only when the designs provided herein meet the flood hazard criteria, comply with all local floodplain ordinances, and are coordinated with local emergency management. Please refer to Section 3.2, Flood Hazard Siting and Elevation, for more detailed guidance.

Your home may be built in accordance with local building codes that take into account the effects of minimum design winds for your area. Building codes require that buildings be able to withstand a “design” wind event. In most inland tornado-prone regions, the building code design wind speed for typical residential construction (usually associated with a severe thunderstorm) is between 105 and 115 mph in the latest editions of the IRC and IBC (2021 editions). For hurricane-prone areas, design wind speeds required by the 2021 IRC and IBC typically range from 115 to 180 mph. However, a tornado or hurricane can cause winds much stronger than those on which local code requirements are based.

In addition to extreme-wind speeds, tornadoes and hurricanes can produce significant wind-borne debris. Inland areas that are outside of the hurricane wind-borne debris region are not required by code to provide debris impact protection for windows and doors that include glazing. Only Miami-Dade and Broward Counties require that all exterior doors and wall systems be designed to resist minimal debris impacts (wall impacts of a 9-pound 2x4 traveling at 34 mph versus safe room wall protection against impacts of a 15-pound 2x4 traveling at 100 mph). This makes the protection of a safe room, where all surfaces of the structure provide extremely high debris impact protection, particularly important. The safe room designs in this publication provide a place to seek safe shelter during these extreme-wind events.

Building codes are adopted at the local or state level in a process that takes model codes, such as the IRC and IBC, and adopts them as the local building code, often with amendments or modifications. Furthermore, local and state codes are often multiple cycles behind the latest model codes. With the incorporation of ICC 500 as a referenced standard in the 2009, 2012, 2015, 2018, and 2021 IRC and IBC, and the 2018 and 2021 IEBC, states and local communities that adopt these codes with the reference to ICC 500 intact require any new portion of a building or facility designated as a tornado or hurricane storm shelter to be constructed to the requirements

WARNING! CODE COMPLIANCE AND EXTREME-WIND EVENTS

Just because a home is built to the minimum requirements of the building code does not mean it can withstand wind pressures or wind-borne debris from extreme-wind events. Even homes with enhanced wind-resistant features will not provide reliable life-safety protection from strong tornadoes or hurricanes that generate wind-borne debris capable of penetrating walls, roofs, windows, and doors.

in ICC 500. ICC 500 codifies much of FEMA’s guidance for safe room design and construction. A safe room constructed to the prescriptive designs included in this publication (and properly sited to address flood hazards) will meet or exceed ICC 500 residential storm shelter design criteria.

2.6 Assessing Your Risk

Use Figure 2-8 to determine the designated wind hazard zone for your location. If you are uncertain of your location because of the level of detail and size of the map or find you live on or very near one of the delineation lines, use the highest adjacent wind zone.

Once you determine your wind hazard(s) from Figure 2-8, find your risk and guidance for your level of risk in Table 2-1.

Note that some areas of the United States are also subject to hurricanes. If you live in one of these hurricane-prone regions (see Figure 2-8), your risk is considered high for the intent of considering a safe room. Homeowners who live near but outside the areas indicated in Figure 2-8 should keep in mind that the area bounded by hurricane-prone regions can fluctuate when wind speed maps are updated. For example, the inland boundary of the hurricane prone region in Figure 2-8 is based on the wind speed map in ASCE 7-16, *Minimum Design Loads and Associated Criteria for Buildings and Other Structures* (the current edition at time of publishing), but ASCE 7-22 is expected to include updated wind speed maps that incorporate improved models and data from more recent events, such as Hurricanes Harvey (2017) and Michael (2018). As a result of the wind speed map updates, the boundary of the hurricane-prone region is anticipated to move landward along the Texas coastline and in northwest Florida. Conversely, the boundary in some areas of the Northeast is expected to move seaward.

HURRICANE RISK

For more detailed information on hurricane risks in the United States, see Chapter 3 of FEMA P-55, *Coastal Construction Manual* (FEMA, 2011a).

RESIDENTIAL SAFE ROOMS

FEMA recommends that residential safe rooms be designed for 250 mph winds regardless of the location of the safe room with respect to the wind zone areas. This is a requirement if receiving FEMA funds.

TABLE 2-1: SAFE ROOM RISK BASED ON LOCATION

TORNADO ZONE OR COASTAL REGION	RISK	GUIDANCE
I	Low Risk	The need for an extreme-wind safe room is a matter of homeowner preference.
II	Moderate Risk	A safe room should be considered for protection from extreme winds.
III and IV	High Risk	A safe room is the preferred method of protection from extreme winds.
Hurricane-Prone Regions and Coastal High Wind Region	High Risk	A safe room is the preferred method of protection from extreme winds. FEMA recommends that all potential safe room occupants comply with local jurisdictional directions and evacuation orders during an emergency event, even if they have constructed a safe room.

LOCAL HAZARD MITIGATION PLANS

Another potential source of information to help homeowners assess risk from tornadoes, hurricanes, and other natural hazards is their “Local Hazard Mitigation Plan.” Over 85 percent of the nation’s population lives in communities with a current Local Hazard Mitigation Plan, as an adopted plan is a condition for receiving certain types of non-emergency disaster assistance, including funding for mitigation projects. For more information on this requirement, visit <https://www.fema.gov/emergency-managers/risk-management/hazard-mitigation-planning>. Refer to Section 4.3.3 for more information on FEMA safe room funding.

To check if your state, local, tribal, and/or territorial government has a Local Hazard Mitigation Plan, visit <https://www.fema.gov/emergency-managers/risk-management/hazard-mitigation-planning/status>.

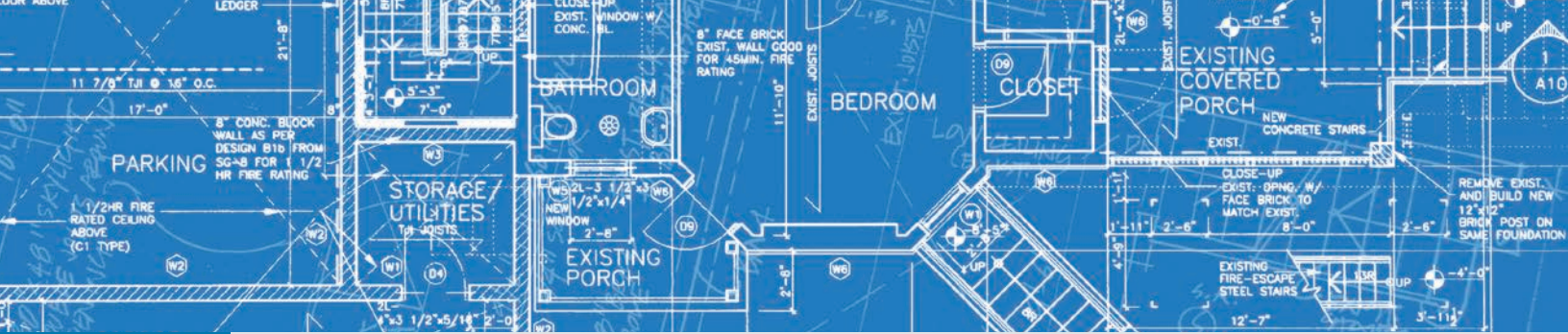

3

Planning Your Safe Room

Now that you better understand your risk from a tornado or hurricane, you can work with your builder/contractor and RDP as necessary to build a safe room to protect you and your family from these extreme windstorms. This section describes the basis of the safe room designs presented in this publication and contains example floor plans showing where you can build a safe room in your home.

MANDATORY EVACUATIONS

If state, local, or emergency management officials call for the mandatory evacuation of an area prior to a hurricane event, property owners and prospective safe room occupants must evacuate as ordered and not occupy their safe room during the incident.

3.1 Design Basis

The purpose of a residential safe room is to provide a space where you and your family can survive a tornado or hurricane with little or no injury. Consequently, all safe room construction documents are required to be signed and sealed by an RDP, unless the safe room is a prefabricated unit that is listed and labeled to indicate compliance with ICC 500 and FEMA P-361 as described in Section 4.2. Even when using the prescriptive designs in this publication, the consulted RDP should carefully review the plans and take into account the actual site conditions where the safe room will be constructed as described in Section 5.2.1 to determine if any modifications are needed to meet the design and construction criteria of ICC 500 and FEMA P-361.

Houses built to a modern building code in hurricane-prone areas, where wind design is required, can better resist wind forces from hurricanes. Similarly, houses built in hurricane-prone areas where wind-borne debris protection is required will have extra protection for the building's openings. However, no building other than a safe room is intended to provide near-absolute protection for sheltering in place during an event.

Most houses, even new ones constructed according to modern building codes, do not provide adequate protection for occupants seeking near-absolute life-safety protection from strong tornadoes or hurricanes, and walls are typically not strengthened against wind-borne debris impact and penetration. A tornado or hurricane can produce extreme wind and wind-borne debris loads on a house that are much greater than those on which building code requirements are based.

Only specially designed and constructed or installed safe rooms that are built to standards well above the minimum code requirements of the IBC and IRC offer life-safety occupant protection during a strong tornado or hurricane. These higher standards are the basis for the requirements and designs included in this publication, and for the criteria and design requirements contained in FEMA P 361 and ICC 500. The safe room designs provided in this publication are based on wind speeds that are rarely exceeded in the United States. Therefore, a safe room built in accordance with these designs is expected to withstand the forces imposed on it by extreme winds without failing; this statement applies to both materials and connections used to build the safe room. The intent of the designs is to enable the safe room occupants to survive an extreme windstorm with minor or no injuries, not for the safe room to remain completely undamaged.

Predicting the exact strength of tornadoes and hurricanes is very difficult due to the complex nature of the storms. That is another reason the safe room designs in this publication are based on extreme wind speeds and why the primary consideration is life safety.

Designing a building, or portion of a building, to resist damage from more than one natural hazard requires different, sometimes competing, approaches. For example, building a structure on an elevated foundation to raise it above expected flood levels can increase its vulnerability to wind and seismic damage. In flood-prone areas, careful attention should be given to the warning time, velocity, depth, and duration of floodwaters. These flooding characteristics can have a significant bearing on the design and possibly even the viability of a safe room.

These considerations, among others, should be thoroughly evaluated during the design process. Your local building official, RDP, or emergency manager can provide you with information about other natural hazards that affect your area and can also recommend appropriate foundation designs and connections to resist prevailing hazards and conditions in your area.

DESIGN REQUIREMENTS

This publication provides FEMA safe room designs that meet or exceed the minimum residential shelter design requirements from FEMA P-361 and ICC 500.

The safe room designs in this publication are applicable to both tornado and hurricane hazards for residential shelters (one- and two-family dwellings with capacity for 16 or fewer occupants) based on design criteria identified in FEMA P-361 and ICC 500.

The safe room design wind speed used for these designs is 250 mph. Safe rooms are designated as “partially enclosed buildings” per *American Society of Civil Engineers’ Minimum Design Loads and Associated Criteria for Buildings and Other Structures* (ASCE 7) to account for possible pressurization of the safe room or a significant drop in atmospheric pressure. Further, the debris impact resistance is based on a 15-pound, 2x4 board missile traveling horizontally and impacting end-on at 100 mph (these are the most restrictive criteria adopted for both tornado and hurricane hazards).

For additional design criteria and information for residential safe rooms, see FEMA P-361 (FEMA, 2021a).

3.2 Flood Hazard Siting and Elevation

A residential safe room should not be placed in any of the flood hazard areas listed in Section 3.2.1. Residential safe rooms located in a flood hazard area that is not listed in Section 3.2.1 should be elevated per the criteria listed in Section 3.2.2. The guidance is also summarized and illustrated in the FEMA Fact Sheet, *Flood Hazard Siting and Elevation Criteria for Residential Safe Rooms* (FEMA, 2021b), which may be downloaded from <https://www.fema.gov/emergency-managers/risk-management/safe-rooms/resources>.

The placement of a safe room in a new or existing home should be scrutinized with respect to flood hazards and meet the most conservative siting requirements between locally adopted codes and ICC 500 (and FEMA P-361 if FEMA funds are utilized). The designer should also ensure that the safe room will withstand the forces of extreme winds and floodwaters, even if it is constructed inside the house, in the event the main house (aka “host building”) is damaged or destroyed.

If your residential safe room is in an area that floods during hurricanes, severe thunderstorms, or flash flooding, it should not be occupied during any hurricane or anticipated flooding event. Further, any safe room in the hurricane-prone region must not be used in violation of any local or state evacuation order.

For information on hurricane evacuation protocols in your neighborhood, contact your local emergency management and law enforcement personnel.

3.2.1 Flood Hazard Siting Criteria

Storm shelters and safe rooms are not allowed in floodways under any circumstance. Unless permitted by the Board of Appeals in accordance with the IRC, all residential storm shelters and safe rooms are required to be located outside the following high hazard areas:

- Flood hazard areas subject to high-velocity wave action (Zone V²) and
- Coastal A Zones (where mapped)

Safe rooms constructed or installed using FEMA funds are also required to receive approval from FEMA for the above-described high hazard area siting variances. Additionally, FEMA-funded residential safe rooms are required to be located outside any areas subject to storm surge inundation associated with any modeled hurricane category, including coastal wave effects (where applicable, these areas should be mapped areas studied by the U.S. Army Corps of Engineers, NOAA, or other qualified agency). Figure 3-1 illustrates acceptable and unacceptable residential safe room locations relative to mapped flood hazards.

DETERMINATION OF SPECIAL FLOOD HAZARD AREAS

Consult your local building official or local floodplain manager to determine whether your proposed safe room site is susceptible to coastal, riverine, or surface water flooding. Designated Special Flood Hazard Areas (SFHAs) for most locations are indicated on Flood Insurance Rate Maps (FIRMs); refer to the Flood Hazard Map Resources textbox in Section 3.2.2 for links to resources.

STORM SURGE RESOURCES

Please see Section B9.1 of FEMA P-361 for online resources to determine if your proposed safe room location is inside or outside areas of storm surge inundation. FEMA recommends working with your local building official, floodplain administrator, or an RDP to make or verify the determination.

As an alternate starting point, many states and localities in hurricane-prone regions designate evacuation zones, which are activated when hurricanes or tropical storms threaten. Evacuation zones typically coincide with storm surge areas; however, homeowners should check with their local officials to verify.

² For the purpose of this publication, Zone V refers to Zones V, VE, and V1–30.

CONCURRENT THREATS: FLASH FLOODING AND TORNADES

As described in Section 2.1, flash flooding can kill during extreme-wind events. However, flash flooding risk is not identified on FIRMs or other widely available flood map products, so it is not included in current safe room siting criteria. As a result, prospective safe room owners should check with local authorities (e.g., floodplain managers, building officials) to determine if their proposed site is in an area at risk of flash flooding. Further, all safe room users should be aware and vigilant regarding all types of National Weather Service warnings, understanding that there can be more than one type of extreme weather warning in effect for the same area at the same time.

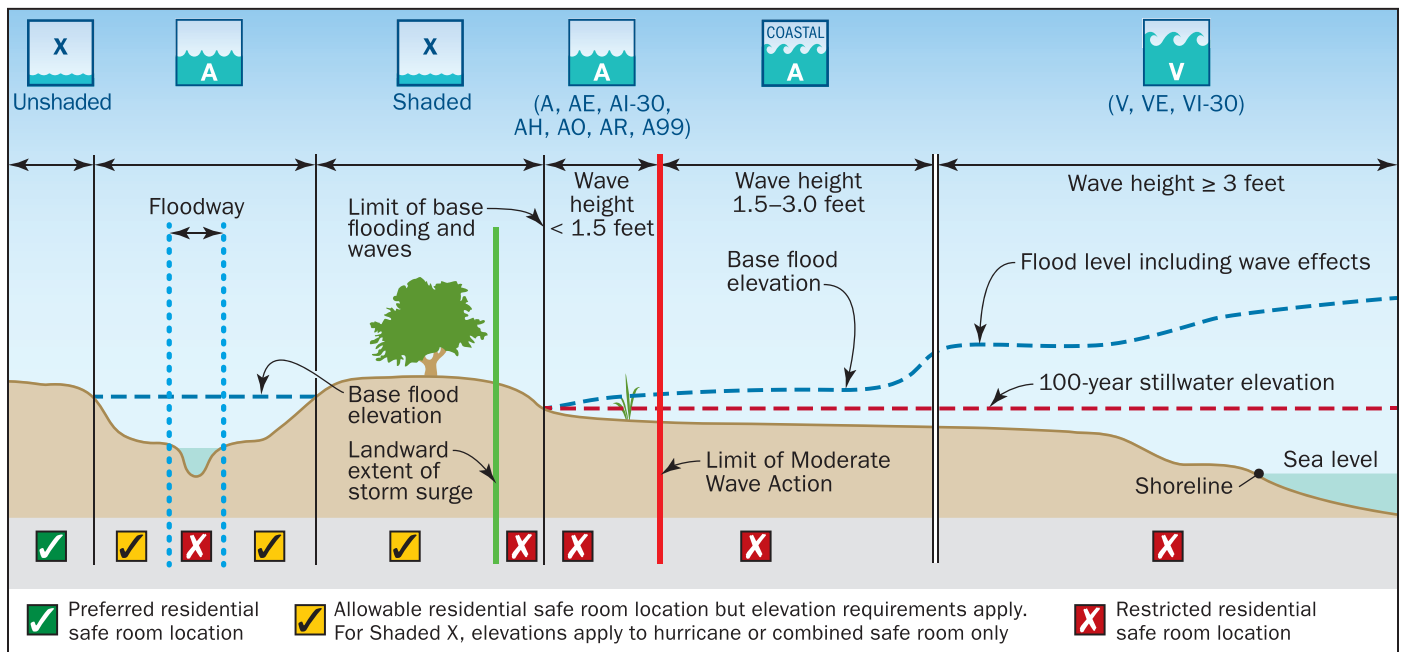

Figure 3-1: Typical riverine cross section and coastal shoreline transect showing areas where residential safe room siting is acceptable or restricted

SOURCE: FEMA FACT SHEET, FLOOD HAZARD SITING AND ELEVATION CRITERIA FOR RESIDENTIAL SAFE ROOMS (2021)

3.2.2 Flood Hazard Elevation Criteria

If necessary, residential safe rooms may be placed in flood hazard areas that have been determined to be in Zone A,³ but still outside the high hazard areas identified in Section 3.2.1. If a residential safe room is desired in Zone A, the safe room should be elevated to or above the highest elevation specified below (refer to the appropriate Flood Insurance Study or Flood Insurance Rate Map [FIRM]):

- The minimum elevation of the lowest floor required by the authority having jurisdiction (AHJ) for the location where the safe room is installed.
- The base flood elevation (i.e., the flood elevation having a 1-percent annual chance of being equaled or exceeded in any given year [100-year event]) plus 1 foot.

³ For the purpose of this publication, Zone A refers to Zones A, AO, AH, A1-30, AE, A99, AR, AR/A1-30, AR/AE, AR/AH, and AR/A, but excludes Coastal A Zones.

- For hurricane safe rooms, the 500-year flood elevation (i.e., the flood elevation having a 0.2-percent annual chance of being equaled or exceeded in any given year).

The flood elevation should be determined using the FIRM adopted by the applicable governing authority (e.g., local floodplain manager); see the textbox below for flood hazard map resources.⁴ Figure 3-2 illustrates the required minimum elevation for safe rooms in flood hazard areas. During a hurricane or thunderstorm, intense rainfall could bring floodwaters above the design flood elevation, and safe rooms without sufficient freeboard could still flood.

TERMINOLOGY

Design flood elevation. The flood protection elevation required by a community, including wave effects, relative to the National Geodetic Vertical Datum, North American Vertical Datum, or other datum. The design flood elevation is the locally adopted regulatory flood elevation.

FEMA recommends that you contact your local floodplain administrator if the safe room is within the Special Flood Hazard Area (SFHA) and within or attached to an existing building to determine whether the project is subject to additional floodplain management requirements. State and local jurisdictions may have requirements that are more stringent than FEMA’s guidance and recommendations. As with all design and construction matters, the local building department and all other AHJs should be contacted to ensure that all state and local requirements are being met, even when using FEMA publication and guidance recommendations.

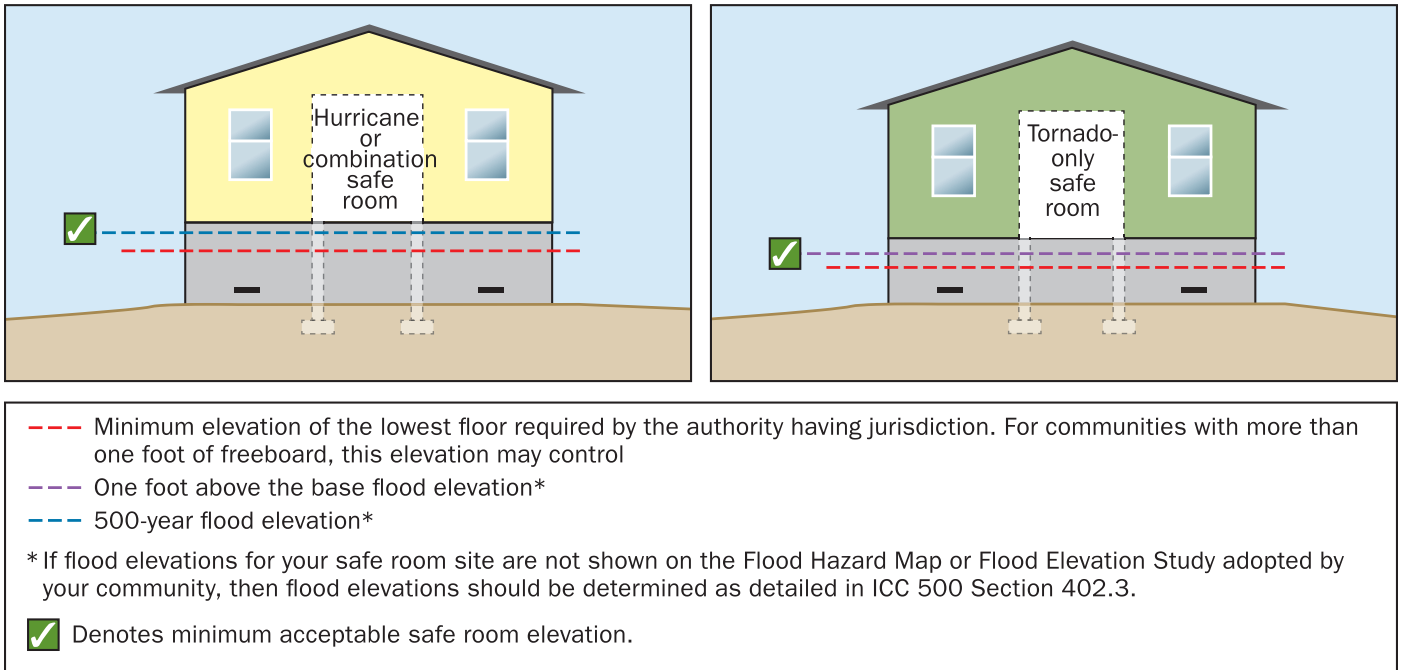

Figure 3-2: The elevation of the safe room floor should be at or above the highest applicable flood elevation indicated

SOURCE: FEMA FACT SHEET, FLOOD HAZARD SITING AND ELEVATION CRITERIA FOR RESIDENTIAL SAFE ROOMS (2021)

⁴ In National Flood Insurance Program-sanctioned communities that have SFHAs identified but have not adopted the FIRM and floodplain management ordinance, residential safe rooms should still be elevated to the base flood elevation plus 1 foot.

Lastly, while not required, prospective safe room owners are encouraged to also consider the elevation of the local flood of record when determining the safe room floor elevation in flood-prone areas.

The design plans presented in this publication can only be elevated a few feet above existing grade (see the design plans for specific foundation details and elevation limitations), and therefore may not comply with flood design criteria for residential safe rooms. In such a situation, have an engineer design a site-specific foundation that elevates the safe room. As previously stated, if state or local or emergency management officials call for the mandatory evacuation of an area prior to a hurricane event, property owners and prospective safe room occupants must evacuate as ordered and not occupy their safe room during the incident.

FLOOD HAZARD MAP RESOURCES

Flood hazard maps for your area can be obtained from multiple sources, including:

- FEMA Map Service Center (<https://msc.fema.gov>)
- Local or state emergency management agencies
- Floodplain managers (<http://www.floods.org>)
- Local building or zoning department

Where the base flood and 500-year flood elevations or riverine floodway locations are not included in the flood hazard map or where a flood elevation study is not adopted, elevations should be obtained as detailed in ICC 500 Section 402.3. The methods in ICC 500 involve either using data available from a source that is approved by the AHJ or having an RDP calculate the elevation.

ADDITIONAL FLOOD HAZARD CONSIDERATIONS

Designers, owners, and communities are encouraged to investigate high-risk flood hazards that may be outside the SFHA and limits of storm surge, but may not be mapped on the FIRM. Where these areas are identified, designers should modify safe room siting and design accordingly. Additionally, sites where any of the following hazards are known to occur should be evaluated carefully before safe rooms are constructed: alluvial fans, flash floods, high-velocity flow, and mudslides. See ASCE 24, *Flood Resistant Design and Construction*, Chapter 3 for additional considerations.

3.3 New versus Existing Homes

By constructing a safe room within your home, you are protecting your family from extreme-wind events. A safe room may be installed during the initial construction of a house or retrofitted afterward. As long as the design and construction requirements and guidance are followed, the same level of protection is provided by either type of safe room. For this discussion, “retrofitting” refers to the process of making changes to an existing building.

The designs in this publication were developed primarily for constructing safe rooms in new houses, but some can be constructed in existing houses as well. When a new house is being built, the builder/contractor can construct walls, foundations, and other parts of the house to accommodate the safe room. Modifying the walls or foundation of an existing home as necessary for the construction of a safe room is generally more difficult and costly. As a result, some of the safe room designs in this publication are not practical for existing homes.

Adding a safe room when first building your home is relatively easy and cost-effective. For example, when the house is to be constructed with exterior walls made from concrete masonry

units (CMUs, also commonly known as “concrete block” [see Figure 3-3]), the protection level as described in this publication can easily be achieved by slightly modifying the exterior walls of the safe room space with additional steel reinforcement and grout and installing or constructing an independent concrete roof deck over the safe room as shown in Figure 3-4. Concrete footings beneath the safe room walls may also need enlarging and additional reinforcement, but when coordinated with placement of the surrounding footings, the level of effort is minimal.

Building a safe room in an existing home typically costs more than building the same safe room in a new house under construction. When installing a safe room in an existing home, the adequacy of the foundation, including basement foundation walls, is a primary concern. The vast majority of slab-on-ground foundations in houses are not designed to transfer the extreme loads from the safe room to the ground, even if they have some level of reinforcement. Retrofitting these slabs is often not feasible, and in many cases a portion of the slab must be cut out where the safe room will be located, and a new, thicker, more heavily reinforced slab with footings must be poured for the safe room. Note that some safe rooms may be heavy enough that an existing slab may be used. Designers can take advantage of this if the dead load (weight) of the safe room plus the weight of the slab at the location of the anchorage is sufficient to resist the uplift and overturning forces on the safe room during a design event. This can sometimes be accomplished when the walls of the safe room are reinforced CMU or concrete. If you plan on taking advantage of this circumstance, you should have an RDP verify that the safe room to be constructed meets requirements specified in ICC 500 Section 307.3.

CONCRETE SLAB-ON-GROUND REQUIREMENTS FOR SAFE ROOMS

To perform properly, the foundation of a safe room must be able to resist the uplift, overturning, and sliding forces from the safe room during an extreme-wind event. In addition to requiring any slab used to support or transfer loads from storm shelter walls to be designed in accordance with the American Concrete Institute’s (ACI’s) ACI 318 or ACI 332, ICC 500 also requires any storm shelter installed on an existing slab using post-installed anchors (anchors installed in concrete that has already hardened) to be subject to special inspections. More information can be found in FEMA’s Fact Sheet, *Foundation and Anchoring Criteria for Safe Rooms* (FEMA, 2021d), which is available for download at <https://www.fema.gov/emergency-managers/risk-management/safe-rooms/resources>.



Figure 3-3: Exterior walls constructed of CMU (New Smyrna Beach, FL, 2007)

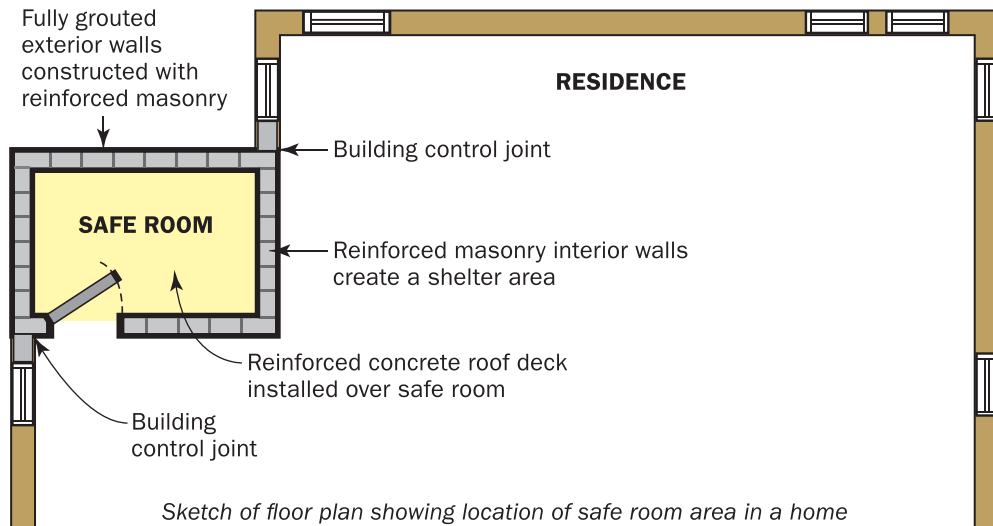

Figure 3-4: In-home safe room under construction; the CMU walls of the safe room are fully grouted and vertically reinforced with steel reinforcing bars from the foundation to the concrete roof deck (New Smyrna Beach, FL, 2007)

3.4 Safe Room Size

The amount of usable floor area that your safe room must provide per person depends partly on the type of windstorm being considered.

Tornadoes are not typically long-lasting storms, so if you are relying on your safe room only for tornado protection, you will not need to stay in the safe room for as long as you would for a hurricane. As a result, comfort is not a primary concern, and a safe room for one- and two-family dwellings that provides at least 3 square feet of floor area per person should be large enough. This allocation of space per occupant also meets the minimum sizing requirements set forth in ICC 500 for residential tornado storm shelters.

When the safe room is intended to provide protection from storms such as hurricanes, which can last for 24 hours or more, the comfort of the occupants should be considered. For a one- or two-family dwelling residential hurricane safe room, the minimum required floor area per person is 7 square feet.

If a potential occupant is in a wheelchair, FEMA recommends that at least 10 feet be provided for this occupant in a tornado or hurricane residential safe room.

The safe room designs in this publication have a gross area of at least 64 square feet and a minimum wall length of 8 feet (for both tornado and hurricane hazards), with a maximum wall height of 8 feet. The maximum floor dimensions in the safe room designs provided in this publication are 14 feet × 14 feet (with a maximum wall height of 8 feet), providing 196 square feet of gross safe room space. As indicated in the introduction, the design occupant capacity for residential safe rooms must be no more than 16 occupants (regardless of dimensions). If you plan to build a safe room outside the dimensions of the design plans provided in this publication, then you will need to consult an RDP to determine whether the modified plans still comply with FEMA P-361 or require additional reinforcement. Chapter 5 includes more information on the sizing of safe rooms that are provided in the design plans.

USABLE SPACE

Consult FEMA P-361 for guidelines on how to identify the net usable floor space and other requirements for a safe room design. Hard fixtures and furnishings within a safe room reduce the gross square footage that is available for occupants.

3.5 Safe Room Locations

For tornado-prone areas, you should locate your safe room so that you can reach it as quickly as possible from all parts of your home, and it should be free of clutter. When determining the siting of a safe room, also consider the accessibility needs of potential occupants. For example, for occupants who use wheelchairs or crutches, the use of stairs in an in-ground safe room may make it difficult to access the safe room in a short amount of time. The following section provides guidance to consider when deciding where to locate your site-built or prefabricated safe room.

3.5.1 Locating Your Safe Room: Above Ground or Below Ground?

If a safe room meets all of the requirements of FEMA P-361, an above-ground safe room is just as safe as a below-ground or in-ground safe room.

For the purposes of this publication, the difference between in-ground safe rooms and basement safe rooms is that in-ground safe rooms are surrounded by soil on all four sides, while basement safe rooms typically are not. In-ground safe room options are not included in the design plans because prefabricated in-ground safe rooms are readily available and more easily installed for residential applications than site-built in-ground safe rooms. For more information on prefabricated safe rooms, see Section 4.2. As with above-ground safe rooms, site conditions should be taken into careful consideration when installing in-ground safe rooms. Specifically, the ground surface should be graded to slope away from the safe room entrance to prevent stormwater runoff from entering safe room. However, the maximum slope is limited where soil cover is used as protection from debris impact, as described in Section B3.2.6.4 of FEMA P-361. FEMA also recommends that a sump pump be provided inside in-ground safe rooms to remove any groundwater or stormwater that may collect inside.

Another unique aspect of in-ground safe rooms concerns anchoring requirements. While above-ground safe rooms must be anchored to prevent sliding or overturning under extreme wind loads, in-ground safe rooms need to be anchored so that rising groundwater will not push the submerged safe room out of the ground with buoyant forces. More information on anchoring in-ground safe rooms can be found in FEMA's Fact Sheet, *Foundation and Anchoring Criteria for Safe Rooms* (FEMA, 2021d), which is available for download at <https://www.fema.gov/emergency-managers/risk-management/safe-rooms/resources>.

Above-ground safe rooms are a great option if you are not able to install a safe room in your basement or in-ground because of issues such as flood hazards, a naturally high groundwater table, or the physical limitations of potential occupants that inhibit access. While in-ground safe rooms provide the inherent missile protection naturally afforded by the surrounding soil coverage, above-ground safe rooms are required to be rigorously tested to ensure that they can also provide missile impact protection. All safe rooms offer life-safety protection when properly designed and constructed or installed.

3.5.2 Locating Your Safe Room: Inside or Outside?

While there are a number of potential locations to construct a safe room inside of a house (including inside a garage or carport), a safe room can also be located outside of the house, either as a detached structure (i.e., away from the house) or adjacent to the house. Keep in mind that in most cases potential occupants will need to exit their home in order to access their exterior safe room. To address this, ICC 500 requires a residential safe room access opening not exceed 150 feet travel distance from the nearest entrance of the residence. When the safe room is located exterior to the house, occupants must endeavor to access it early enough to prevent injuries from wind and wind-borne debris, as well as large hail and torrential rain. Like interior safe rooms, exterior safe rooms can be either above-ground or in-ground. However, if you are located in an SFHA (as outlined in Section 3.2), siting the safe room below ground or below the design flood elevation is not permitted by ICC 500 and will not qualify for FEMA funding assistance.

Although an interior safe room has the benefit of being closer to the home's occupants, an exterior safe room may be easier to install for an existing home. An interior safe room constructed in an existing home would typically require substantial retrofitting. By contrast, a separate, detached safe room located outside a house would not require modifications to the home and would likely be more affordable and feasible for existing homes. They could even be added

onto a new or existing covered porch or patio. Safe rooms located outside of a building also require exterior weather protection per minimum building code requirements, such as weather stripping under exterior doors. The protection required will depend on local codes as well as the type of material used for the exterior walls and roof. Per ICC 500, hurricane safe rooms require weather protection against the design event for any areas of the exposed building envelope. However, interior residential safe rooms that are fully enclosed by the host building do not require exterior weather protection.

Safe room entrance locations should be considered along with the location of the safe room itself. Entrances that are accessible without having to go outside and be exposed to potential wind, wind-borne debris, large hail, and torrential rain are preferable, though may not be feasible in all cases. Safe rooms placed adjacent to the main building could have an entrance directly into the safe room from the main building, or it could have an entrance from the outside as shown in Figure 3-5.



Figure 3-5: An above-ground safe room constructed as an addition to a slab-on-ground home in a way that matches the aesthetics of the house (outside Tuscaloosa, AL, 2011)

3.5.3 Locating a Safe Room Inside a Home

There are several possible locations within your home for a safe room. It can be above-ground, in-ground, or in a basement.

Regardless of where in your home you choose to install your safe room, it must be able to resist the same wind pressures and wind-borne debris as a stand-alone exterior safe room because the surrounding structure may be completely blown away by extreme winds (see Figure 3-6). Closets, interior bathrooms, and small storage rooms offer the advantage of having a function other than providing occasional storm protection. Typically, these rooms have only one door and no windows, which makes them well suited to also be a safe room in addition to their regular function.

If sections of your home's walls are used as safe room walls, those wall sections must be designed for the wind pressure and debris impact resistance outlined in FEMA P-361. As outlined in ICC 500, any connections between the safe room and host building must be designed such that the safe room can resist the greatest load the connection is capable of transferring. This is to ensure the structural integrity of the safe room in case the rest of the structure fails or is compromised during an extreme-wind event.

Figure 3-6: Above-ground residential safe room that was in the garage of a home hit by an EF5 tornado in Joplin, MO (2011)



3.6 Floor Plans Showing Possible Safe Room Locations

This section shows three typical floor plans with possible locations for safe rooms. These floor plans were not developed for any specific house; rather, they show how safe rooms can be added without changing the layout of rooms. Regardless of where the safe room is built, it must be equipped with a door that has been tested, listed, and labeled to the appropriate criteria and will resist the wind pressure and impact of wind-borne debris. See Section 4.1.2 for more information on selecting a door for your safe room. Further, safe room wall and roof assemblies should be structurally independent of surrounding non-safe room assemblies. If any non-safe room element is connected to the safe room, then the safe room must be evaluated to ensure it can resist the greatest force the connection is capable of imparting before the connection fails (i.e., the connector must be weaker than the safe room). Refer to Section 3.4 for guidance on safe room sizing and how to determine useable floor area.

3.6.1 Floor Plan 1: Basement

Possible safe room locations in a basement are shown in Figure 3-7 and include the following:

- A space using one or more exterior walls of the basement
- A freestanding structure within the basement (not using the basement walls)

A space that is to be used for a safe room should be kept free of clutter so that the safe room can be quickly and easily entered and so that the safe room occupants will not be injured by falling objects. For this reason, a bathroom is often a better choice for a safe room than a closet or other space used for storage. Basements are not suitable locations for safe rooms when a flood hazard is present. For more information on flood hazards to consider, see Section 3.2.

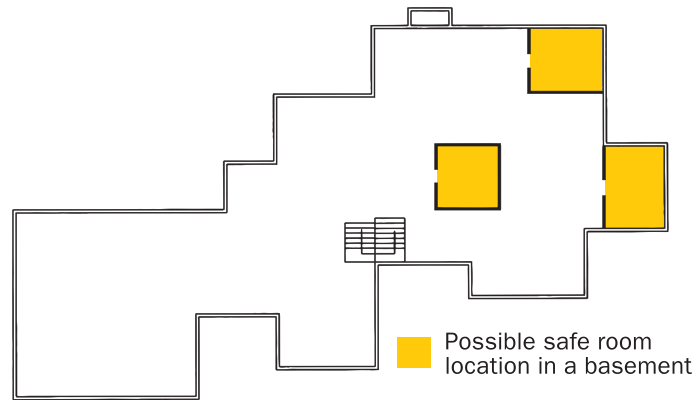

Figure 3-7:
Floor Plan 1: Possible safe room locations in a basement

3.6.2 Floor Plan 2: Safe Rooms on the Primary Level of a Home

Possible safe room locations in a house on a slab-on ground or crawlspace foundation are shown in Figure 3-8 and include the following spaces on the first floor:

- Bathroom
- Closet
- Laundry room
- Corner of the garage (above-ground installation)
- Outside within 150 feet travel door-to-door

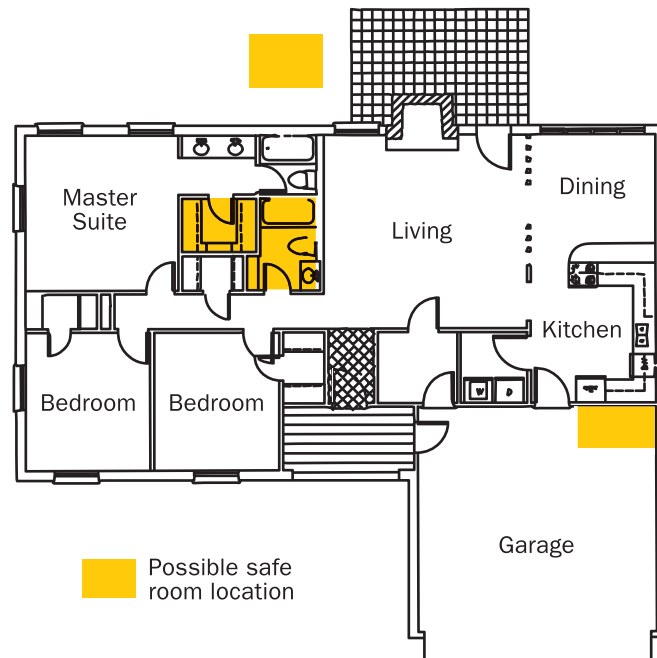

Figure 3-8:
Floor Plan 2: Possible safe room locations for a house on a slab-on-ground or crawlspace foundation

3.6.3 Floor Plan 3: In-Ground Safe Rooms

Possible locations for an in-ground safe room are shown in Figure 3-9 and include the following:

- Below the floor of the garage
- Below ground within 150 feet travel distance from the house

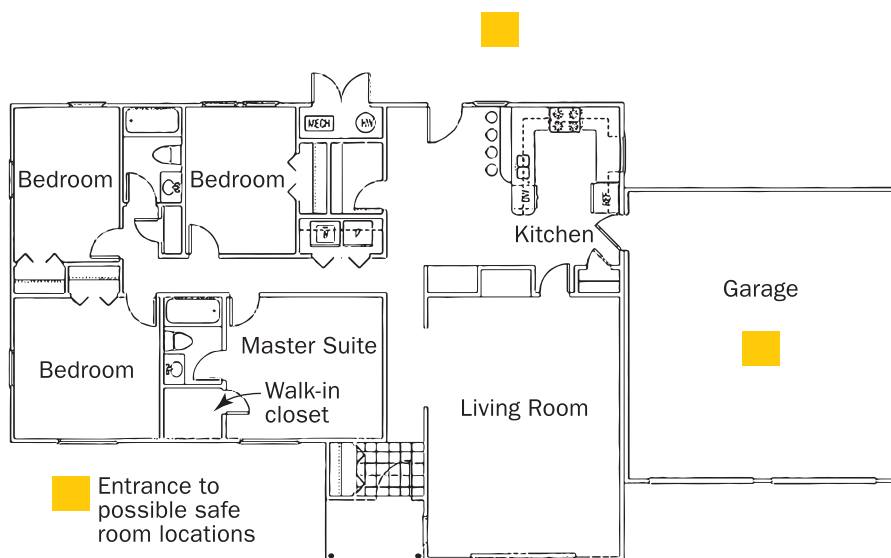

Figure 3-9:
Floor Plan 3: Possible in-ground safe room locations for a house without a basement

When deciding whether to choose an in-ground safe room, make sure the potential for flooding is considered (see Section 3.2 for more information). For safe rooms located in garages, also consider any potential obstacles (such as a parked car). In the event of a tornado, the safe room users should not be blocked from entering and exiting the safe room. Additionally, when installed below the floor slab, FEMA recommends choosing a design that keeps runoff, or water from a leaking or burst water heater, from flowing into the safe room.

3.6.4 Selection of Safe Room Type and Location

Figure 3-10 will help you decide what type of safe room is appropriate for your circumstances. The figure provides considerations for both new and existing homes, with some considerations being indicated as only applying to constructing or installing a safe room in an existing home. Bear in mind that these are general considerations and would not necessarily be true in every situation. It is recommended that homeowners speak with an RDP about considerations for their specific situation.

Table 3-1 will help you consider the options of connections to a house, exposure (above-ground or in-ground), construction type, applicability to new or existing homes, and access (depending on whether the safe room is inside or outside of the house). The right-most column in the table also indicates whether this publication has a safe room prescriptive solution that applies to this type of safe room.

Safe Room Considerations for Both New and Existing Homes

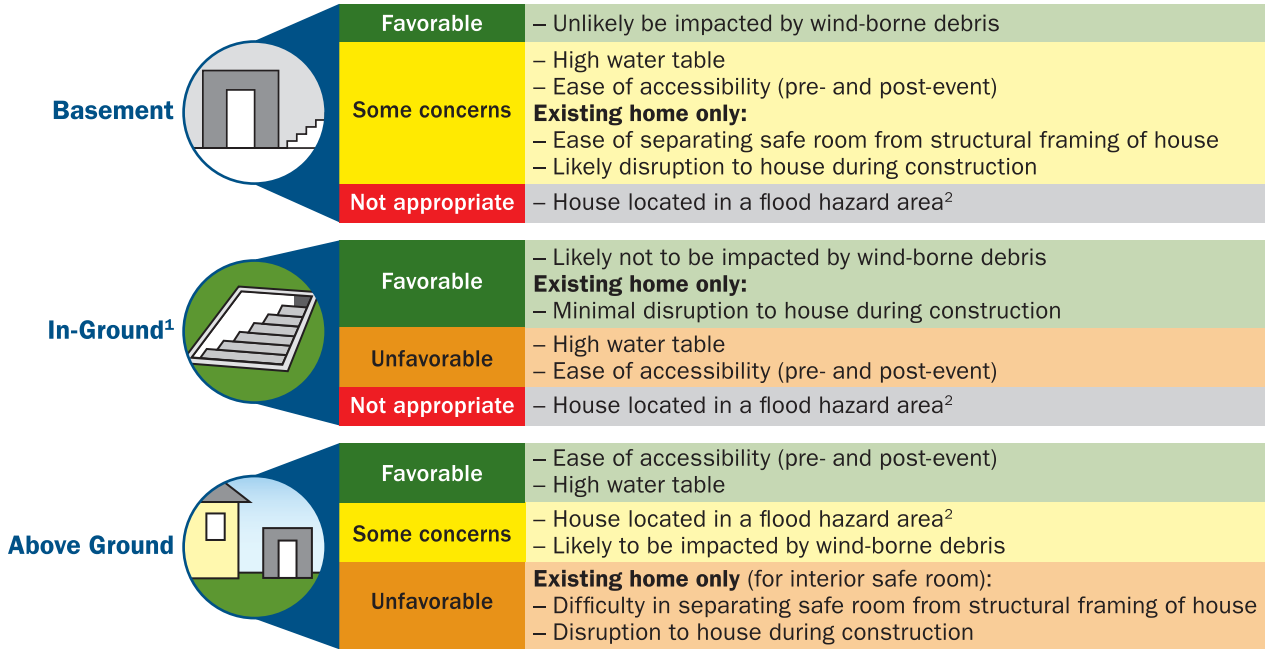

NOT APPROPRIATE FOR ANY LOCATION WHERE HOUSE IS LOCATED IN STORM SURGE AREA

¹ This publication does not contain any designs for site-built in-ground safe rooms, as prefabricated in-ground safe rooms are typically more constructible and affordable.

² Per flood design criteria for FEMA safe rooms (see Section 3.2), elevation of a safe room is only permitted when specific flood design criteria have been met and when approved by the jurisdictional authority responsible for evacuations and NFIP compliance.

Figure 3-10: Appropriate types of safe rooms for new and existing homes

TABLE 3-1: CONSTRUCTION, APPLICABILITY, AND ACCESS FOR SAFE ROOMS

CONNECTION TO HOUSE	EXPOSURE	CONSTRUCTION		APPLICABILITY		ACCESS		FEMA P-320 SAFE ROOM DESIGNS
		PREFABRICATED	SITE-BUILT	NEW HOME	EXISTING HOME	INSIDE HOME	OUTSIDE HOME	
Detached	Above ground	Yes	Yes	Yes	Yes	No	Yes	Yes
	In ground	Yes	Yes	Yes	Yes	No	Yes	No
Below	In ground	Yes	Yes	Yes	Yes	Yes	Yes	No
Inside	In basement	Yes	Yes	Yes	Yes	Yes	Yes	Yes
	Above ground	Yes	Yes	Yes	Yes	Yes	Yes	Yes
Attached	Above ground	Yes	Yes	Yes	Yes	Yes	Yes	Yes

3.7 Foundation Type

Houses and other buildings vary in construction type as well as foundation type. Buildings may have heavy wall systems, such as masonry or concrete, or they may have light wall systems, such as wood framing, metal stud framing, or structural insulated panels. Regardless of the structure type, the following types of foundations may be suitable for the installation of a safe room:

- Basement
- Slab-on-ground with footings and reinforcement
- Crawlspace or pile (however, prescriptive solutions for pile foundations are not included in this publication)

3.7.1 Basement Foundation Applications: New Construction

In a new house with a basement, the safe room is often built in the basement. You can build the safe room as an entirely separate structure with its own walls, or you can use one or more of the exterior basement walls as walls of the safe room (see Figure 3-11). Basement walls with sufficient soil cover do not have to pass testing for resistance to debris impact (see Chapter B3 of FEMA P-361 for more information), though they still need to be able to resist lateral loads from retained soils.

Figure 3-11: Cross section: Typical new construction basement foundation with safe room (reinforcement is shown for illustrative purposes only and will vary depending on safe room design)

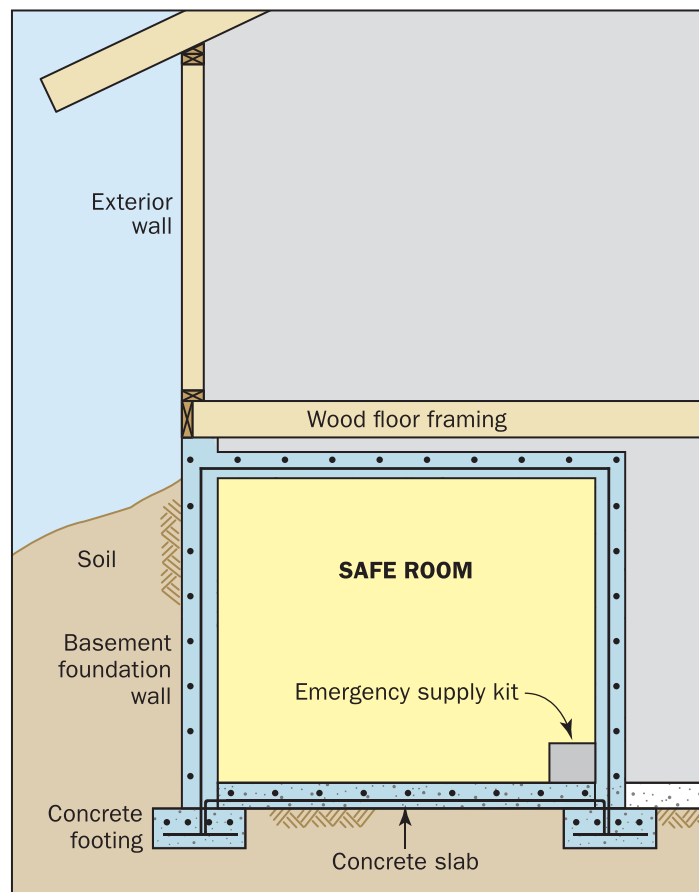

Basement wall sections that extend above grade are required to resist lateral wind pressures and missile impacts specified in FEMA P-361. Because typical reinforcement techniques used in residential basement walls may not provide sufficient resistance to safe room wind loads and missile impacts, reinforcement will likely need to be strengthened (rebar size increased and/or spacing decreased) where exterior basement walls extend above grade and enclose the safe room.

BASEMENT WALLS

In order to economically utilize basement walls as part of a safe room, the safe room should be integrated into the design and construction process during the new construction phase.

For new construction, your builder/contractor can reinforce the walls used for the safe room (refer to the Sheet SR1.4 of the Design Plans). For existing construction, reinforcing the walls is often not feasible, and when it is feasible, it is typically cost-prohibitive. In such cases, the safe room can be installed away from the exterior basement walls instead.

3.7.2 Basement Foundation Applications: Existing Construction

A house with a basement is usually built on a foundation constructed of CMU or cast-in-place concrete walls supported by concrete footings. Existing foundation walls, especially those in older houses, will likely not meet the requirements for a safe room.

In addition, the safe room designs provided in this publication take into account that the safe rooms may experience loading from debris when a surrounding structure collapses during an extreme-wind event, which in the case of a basement safe room is the rest of the house above it. The roof decks of these safe rooms are designed to limit the damage that may result from debris impact or accumulation of construction materials from the collapsed house. Although the house may collapse around the safe room, installing the safe room in the basement is still appropriate if it is designed and constructed to perform independently of the structure that surrounds it.

EXISTING SPACES

When determining whether an existing wall, foundation, or roof can be used for a safe room, the specific existing configuration must be carefully evaluated to determine its capacity. The proposed safe room should be planned as a structurally separate space to prevent it from relying on existing components that were designed to provide much lower levels of performance. Any existing building elements that would be structurally relied upon by the safe room would likely need to be replaced.

When using the design plans provided in this publication, an RDP should review them to verify that the actual site conditions fall within the limitations provided on Sheets SR0.2 and SR0.3; the items requiring verification are summarized in Section 5.2.1. For most one- and two-family dwellings, the minimum safe room roof loading (100 psf) is sufficient to account for the residential structure above collapsing and settling on the safe room roof.

In addition to the roof and exterior walls, the foundation of a basement safe room should be adequate to resist the overturning and uplift forces of an extreme-wind event. If the basement has an unreinforced or insufficiently reinforced slab of typical thickness (approximately 4 inches), there may not be enough resistance associated with the dead load of the safe room plus the slab weight and/or strength of connection to the slab to counteract potential wind forces. In general, adding a basement safe room during the construction of a new house is easier than retrofitting the basement of an existing home. If you plan to add a basement safe room as a retrofitting project, keep the following in mind:

- Exterior basement walls containing less reinforcement than specified on the design plans provided with this publication should be evaluated by an RDP to determine whether they meet FEMA P-361 criteria.
- Exterior basement walls that are used as safe room walls but not protected by soil must not contain windows, doors, or other openings in the area providing protection unless they are replaced with impact protective systems listed and labeled for compliance with ICC 500.
- Smaller openings such as utility penetrations in the safe room walls or roof where the opening size is greater than 3-1/2 square inches for rectangular openings or 2-1/2 inches in diameter for circular openings must be protected with ICC 500-compliant devices.
- The roof of the safe room must be separate from the floor above. Refer to Sheet SR1.4 of the safe room design plans in this publication for details.

3.7.3 Slab-on-Ground Applications: New and Existing Construction

A slab-on-ground house (see Figure 3-12) is built on a concrete slab that is constructed on compacted or undisturbed soil.

Figure 3-12: Cross section: Typical slab-on-ground foundation with safe room (reinforcement is shown for illustrative purposes only and will vary depending on safe room design)

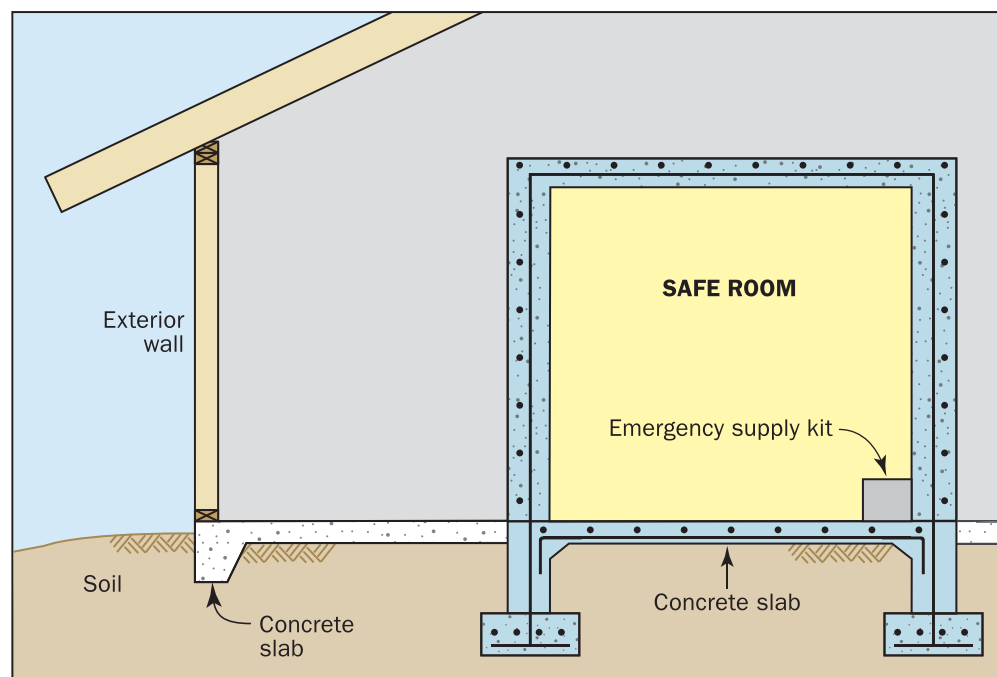

Concrete slabs require steel reinforcement to prevent propagation of cracking. Loads on slabs, and stresses induced by temperature and moisture changes, can cause concrete to crack. Steel reinforcement in concrete slabs helps hold the concrete together, which limits crack widths and controls the spacing of cracks. Where supporting a safe room, the reinforcement is also needed to resist the tension resulting from extreme-wind loads acting on the safe room. If you are building a new slab-on-ground house and want to install a safe room (of any material or type), the safe room foundation must be able to resist loads transferred from safe room wall anchors and keep the safe room from overturning or sliding. The prescriptive design plans in this publication specify independent footings beneath each safe room wall, but many above-ground prefabricated safe

rooms rely on reinforced thickened slabs. In any case, if you decide to change the foundation type specified for your safe room, you will need to consult with an RDP to redesign the foundation and provide the new details to your building code official and contractor.

In an existing home, removing part of the slab and replacing it with a thickened section or footing to support a safe room would involve some disruption inside the home. Building a safe room, particularly with lightweight wood-framed walls (with appropriate reinforcement to meet safe room design criteria), in an existing slab-on-ground home may not be practical unless a new slab is poured or the existing slab can be shown to have reinforcement and thickness adequate to support the safe room. If you are considering the option of using the existing slab to support the safe room, then it is critical to have the slab evaluated prior to installing the safe room. If the evaluation determines the existing slab fails to meet the design specifications, the existing slab should be cut out around the perimeter of the safe room and replaced by a thickened slab or other foundation system that meets or exceeds the engineering specifications for the chosen safe room design or prefabricated unit. More information is available in FEMA’s Fact Sheet, *Foundation and Anchoring Criteria for Safe Rooms* (FEMA, 2021d), which is available for download at <https://www.fema.gov/emergency-managers/risk-management/safe-rooms/resources>.

In some cases, heavy safe rooms that do not require the dead load of the slab for resistance may be installed on existing slabs, as discussed in Section 3.3. Lighter safe rooms may require more dead load (weight of the structure and slab or foundation) to resist uplift, overturning, and sliding forces. This dead load can be attained by installing a thickened slab foundation or footings under the walls of the safe room.

Wherever the safe room is connected to an existing slab foundation using “post-installed” anchors (i.e., hardened concrete or masonry is drilled to insert new anchors), ICC 500 requires a special inspection to verify that the engineered design specifications for the anchors and foundation are met or exceeded in the field. Specifically, the inspection must determine whether site conditions satisfy the following: (1) minimum foundation capacity requirements including foundation thickness, steel reinforcement, and concrete cover, and (2) storm shelter installation requirements, including anchor location, minimum edge and end distance, and minimum required capacity for all anchors installed in hardened concrete.

You can also build a safe room as an addition to the outside of a slab-on-ground house (as shown in Figure 3-5). This type of safe room must have not only an adequate foundation, but also exterior weather protection (for more information on exterior safe rooms, see Section 3.5.2). In general, adding a safe room during the construction of a new slab-on-ground house is easier than retrofitting an existing slab-on-ground home. If you plan to add a safe room to a slab-on-ground home as a retrofitting project, keep in mind that the walls of the safe room must be completely separate from the structure of the house unless the existing walls have adequate reinforcement or are reinforced as part of the retrofit to meet the safe room criteria.

SOIL CHARACTERISTICS

Although heavier safe rooms, such as those constructed of concrete and CMU, are more likely to resist forces imparted by extreme wind pressures, an RDP may need to verify that the soil will be able to carry the weight of the safe room.

3.7.4 Crawlspace or Pile Applications: New and Existing Construction

A house built on a crawlspace (see Figure 3-13) usually has a floor constructed of wood framing. Along its perimeter, the floor is supported by the exterior foundation walls. The interior part of the floor is supported by girders that rest on a foundation wall or individual piers. Crawlspace foundation walls may be concrete or constructed of CMU blocks. Because crawlspace foundations are often unreinforced or lightly reinforced, they provide little resistance to the stresses caused by extreme winds.

Building a safe room inside a house on an existing crawlspace foundation is complicated. The main reason is that the entire safe room, including its floor, must be separate from the framing of the house or, alternatively, the entire floor system and foundation of the house must be constructed to support the extreme-wind loads acting on the safe room. Figure 3-13 illustrates a safe room built inside the house without using the floor system of the structure itself. In this option, the safe room has a separate concrete slab floor installed on top of compacted earth fill and must be supported by reinforced concrete or CMU foundation walls. In areas where slab-on-ground construction is problematic because of expansive clay-type soils, the floor system may be designed as open and elevated, or a post-tensioned slab-on-ground foundation could be designed and constructed. However, developing a prescriptive solution for that design option is difficult and, therefore, is not addressed in this publication. An alternative approach for areas where slab-on-ground construction is feasible is to build an exterior safe room on a reinforced slab-on-ground foundation adjacent to an outside wall of the house and provide access to the independently constructed safe room through the exterior wall.

Figure 3-13: Cross-section: Typical crawlspace foundation with safe room (reinforcement is shown for illustrative purposes only and will vary depending on safe room design)

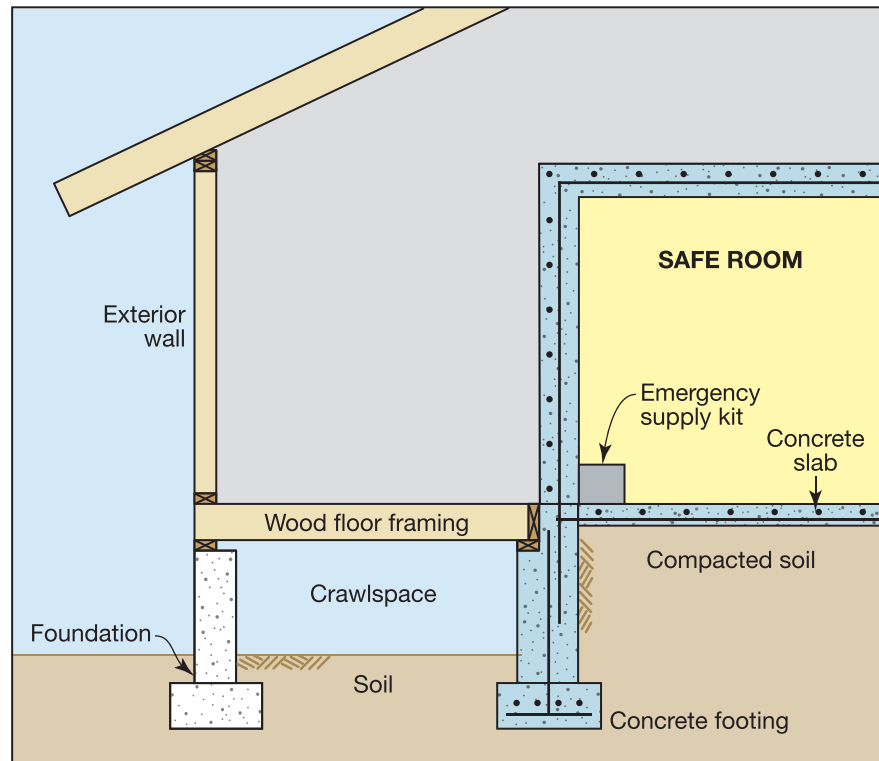

Ventilation in the area below the floor of the house is also an important consideration. The wood-framed floor of a house on a crawlspace foundation is typically held 18 to 30 inches above the ground by the foundation walls for compliance with the building code. The space below the floor is designed to allow air to flow through so that the floor framing will not become too damp. This air flow should not be impeded by the installation of the safe room. If your residence was intentionally designed with an unvented crawlspace for moisture control and energy savings, venting should not be added without consulting with an RDP.

4

Consumer Guidance

This chapter provides consumer guidance for homeowners, builders, and contractors preparing to install safe rooms in one- or two-family dwellings. Construction materials and safe room door assemblies for site-built safe rooms like the ones built from the construction plans included in this publication are addressed in Sections 4.1. Prefabricated safe room options are discussed in Section 4.2. Cost information for safe rooms and safe room components is provided along with guidance on FEMA safe room funding opportunities in Section 4.3.

Although this publication presents FEMA’s guidance on the design and construction or installation of residential safe rooms, FEMA does not verify or certify design calculations or testing for any product. Further, FEMA does not endorse, approve, certify, or recommend any contractors, individuals, firms, or products. Contractors, individuals, or firms are not allowed to claim they are “FEMA approved” or “FEMA certified” or produce products that are advertised as such. When selecting a safe room contractor, FEMA recommends that you research contractors in your area to assess their familiarity with FEMA P-320 and FEMA P-361. Alternatively, you may wish to contact your state emergency management agency to see if they have a state-wide certification for contractor-built safe rooms. The contact information for state emergency management offices/agencies can be found at <https://www.fema.gov/grants/mitigation/state-contacts>. Some states have certifications, others do not.

Vendor claims of compliance with FEMA and ICC criteria should be verified through independent testing or engineering analysis. Fortunately for consumers, all storm shelter impact protective systems, including storm shelter door assemblies, are required to be listed and labeled to demonstrate compliance with ICC 500 (see Section 4.1.2 for more information on labels). Additionally, the latest edition of ICC 500—with which all FEMA-funded safe rooms must comply—has been updated to require that signed and sealed construction documents be submitted for each permit application for all residential storm shelters unless they are prefabricated units listed and labeled to demonstrate compliance with ICC 500. As with labeled impact protective systems, labeled safe rooms should denote compliance with the latest edition of ICC 500. More information on prefabricated safe room and labeling requirements is provided in Section 4.2.

HOW CAN I CONFIRM MY HOME HAS AN EXISTING P 361-COMPLIANT SAFE ROOM OR ICC 500-COMPLIANT STORM SHELTER?

Please note that FEMA does not provide inspection services, nor endorse, approve, certify, or recommend any contractors, individuals, firms, or products. Contractors, individuals, and firms, are prohibited from stating that they are, or produce products that are, “FEMA approved” or “FEMA certified.”

Your State Hazard Mitigation Officer (SHMO) may be able to recommend a qualified safe room inspector. A list of SHMOs can be found at <https://www.fema.gov/grants/mitigation/state-contacts>.

The age of the safe room or storm shelter is a key factor in determining which criteria were in effect when the product was designed and constructed or installed. FEMA P-361 was introduced in 2000 and updated in 2008, 2015, and 2021. ICC 500, which is referenced in the model building codes and includes the minimum requirements for residential and community storm shelters, was first published in 2008 and updated in 2014 and 2020.

Lastly, an independent RDP licensed in your state and familiar with safe room design and construction may also be consulted to verify that the safe room meets or exceeds the criteria found in FEMA P-361 or ICC 500.

TERMINOLOGY

Label (ICC 500)

An identification applied on a product by the manufacturer that contains the name of the manufacturer, the function and performance characteristics of the product or material, and the name and identification of an approved agency and that indicates that the representative sample of the product or material has been tested and evaluated by an approved agency.

Labeled (ICC 500)

Equipment, materials or products to which has been affixed a label, seal, symbol or other identifying mark of a nationally recognized testing laboratory, approved agency or other organization concerned with product evaluation that maintains periodic inspection of the production of the above-labeled items, and whose labeling indicates either that the equipment, material or product meets identified standards or has been tested and found suitable for a specified purpose. See also “Label.”

Listed (ICC 500).

Equipment, materials, products or services included in a list published by an approved organization and concerned with evaluation of products or services that maintains periodic inspection of production of listed equipment or materials or periodic evaluation of services and whose listing states either that the equipment, material, product or service meets identified standards or has been tested and found suitable for a specified purpose.

4.1 Site-Built Safe Rooms

The consumer guidance in this section is intended to supplement Chapter 5 content on “Building Your Site-Built Safe Room” using the prescriptive construction plans included in this publication. As an alternative to the FEMA construction plan options, homeowners may choose to have a customized safe room designed and sealed by an RDP to meet their specific needs. The following sections provide guidance on selecting construction materials and door assemblies needed for site-built residential safe rooms.

4.1.1 Construction Materials

The materials your builder/contractor will need to construct the foundation, walls, and roof of a site-built FEMA P-320 safe room according to the prescriptive plans provided in this document may not be always stocked by home improvement stores but should be available from building material suppliers. These materials have been carefully selected for their strength, durability, and ability to be readily combined in ways that enable them to withstand the forces of extreme winds and the impact of wind-borne debris. Most customized safe room designs specify details using similar materials. Regardless of the source of your engineered safe room plans, it is critical to purchase the materials, connectors, and components specified to achieve the purpose of life-safety protection from extreme-wind events. Any substitutions should be approved by the RDP in responsible charge.

Adherence to plan detail specifications and construction notes—both ‘General Notes’ on Sheet SR0.2 and material-specific notes on Sheets SR0.2 and SR0.3—requires careful study of the plans but is absolutely critical to a safe room’s life-safety performance capability. To illustrate the point, consider the following example: Detail 6 on Sheet SR1.3 of the Safe Room Construction Plans specifies the framing lumber size and spacing required for walls: two 2x6 studs at 12 inches on center. However, the lumber species and grade for wood-framed wall and roof assemblies are specified in the General Wood Framing Notes on Sheet SR0.3 along with other vital information needed when selecting and installing the product. In addition to the specified lumber’s material strength that is needed by the individual wall and roof members to resist extreme-wind loads, the species and grade specifications are necessary for the wood connectors (specified on Sheet SR0.4) to perform as designed. In other words, the systems are interdependent, and like a chain, only as strong as its weakest link. Therefore, if the specified lumber species and grade (or higher grade) are unavailable from your regular supplier, then it will be necessary to find another supplier, such as a contractor’s lumberyard, to get the materials needed to install the wood-framed safe room option. Similar interdependence of requirements and specifications exist for every site-built safe room plan provided in this document. Consequently, it is important to scrutinize every specification and ensure that all the requirements are met. One day, you and your family’s lives may depend on how well those specifications were followed.

4.1.2 Safe Room Door Assemblies

Like any other room, safe rooms must be accessed through an opening or door. Just as the walls and roof of a safe room are designed and built to protect against extreme winds and wind-borne debris, so must the safe room door assembly. The door assembly includes the door panel, hardware (locks and hinges), frame, and attachment devices used to anchor the door frame to the surrounding safe room wall. When careful selection and installation of the safe room door

assembly is overlooked, a door failure can leave occupants at great risk of injury or death during a tornado or hurricane. Steel doors commonly used in residential and commercial construction cannot withstand the pressure and missile impact tests specified in ICC 500. Only door assemblies designed, tested, listed, and labeled to resist the specified debris impacts and wind pressures are capable of providing life-safety protection.

Prior to ICC 500 (first edition, 2008), testing criteria for safe room door assemblies were less clearly defined. Likewise, the market for safe room door assemblies was less developed and primarily focused on the needs of community safe rooms. Because of the lack of standardization and product availability, residential safe room owners and contractors had to improvise by building their own doors based on templates of models that had passed previous testing. But without quality-controlled materials, equipment, and expertise needed to manufacture and verify safe room door assemblies, the resulting products would almost certainly fail the rigorous testing methods now required by ICC 500 and FEMA P-361. Today, many residential safe room door assemblies are available to meet the updated testing, listing, and labeling requirements and provide near-absolute protection when installed as specified by the manufacturer.

Testing and Labeling

Being well informed is important when determining whether a door assembly has been tested to the appropriate criteria. ICC 500 and FEMA P-361 require that successful certification of compliance be demonstrated by labels attached to approved doors by third-party certification agencies. Consumers should verify the door assembly's compliance with the most current versions of FEMA P-361 and ICC 500 for a tornado wind speed of 250 mph by carefully checking the door's certification label, which contains information on impact and design pressure performance. While a label may not state that it complies with FEMA P-361, it should state that it was tested in accordance with ICC 500 for a tornado wind speed of 250 mph (i.e., the label should indicate an impact of 15 lb 2x4 @ 100 mph and wind pressures that vary based on the size and location of door⁵). In the same vein, a label is not required to reference FEMA P-320. Although there is no universal format for safe room door labels, ICC 500 requires they provide specific performance details, as well as the manufacturer's third-party listing information for the product. A representative example is shown in Figure 4-1. Note the label shown in this figure references the previous editions of FEMA P-361 and ICC 500, which were published in 2015 and 2014, respectively. The label marking requirement in the 2020 edition of ICC 500 includes the same basic information, except that new products installed in FEMA-funded safe rooms or storm shelters where ICC 500-2020 is adopted should reference ICC 500-2020.

Tested door assemblies are typically not available off the shelf in most home improvement stores but can be purchased through commercial building product suppliers or safe room/storm shelter component suppliers. For more information, see the *Residential Tornado Safe Room Doors* Fact Sheet (FEMA, 2021c), which includes directories for safe room doors that have passed the required testing. It can also be downloaded at <https://www.fema.gov/emergency-managers/risk-management/safe-rooms/resources>.

⁵ Refer to the "Residential Tornado Door Pressures" table on Sheet No. SR2.2 for wind pressures determined for typical door sizes based on their location along the safe room wall.

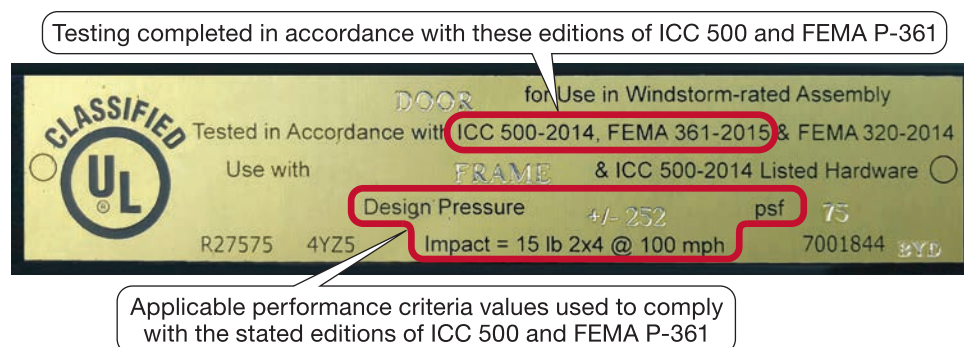

Figure 4-1: Example door label for a product that has been tested to safe room criteria

Installation

Selecting and purchasing your ICC 500- and FEMA P-361-compliant, labeled safe room door assembly is step one; step two involves compliant installation of the door assembly in the same way it was successfully tested and certified by following the manufacturer's instructions. Door frame anchorage configurations that differ from what were successfully tested need to be designed in accordance with ICC 500 unless the manufacturer provides directions for anchorage to different wall types or configurations through reference to an engineer's report that demonstrates the alternative anchorage meets or exceeds the strength of the tested assembly.

4.2 Prefabricated Safe Rooms

As an alternative to site-built safe rooms, such as the prescriptive solutions provided in this publication, a variety of prefabricated safe rooms are commercially available. The prefabricated safe room industry has grown tremendously since the early 2000s, particularly for residential applications. A prefabricated safe room is a safe room that has been assembled off site, typically in a manufacturing facility, and transported to the site where it will be installed.

4.2.1 Testing and Labeling

As with safe room impact protective systems, like site-built safe room door assemblies, the walls, roof, and doors of prefabricated residential safe room units must be tested and certified to resist extreme wind pressures and impact from the 15-pound 2x4 test missile traveling at 100 mph. While safe room door assembly manufacturers who provide assemblies for site-built safe rooms have been listing and labeling their products since as early as the first edition of ICC 500, prefabricated safe room manufacturers have typically demonstrated compliance with ICC 500 testing requirements through test reports from certified testing facilities. However, as noted in the introduction of this chapter, changes to the 2021 IRC and ICC 500-2020 now require that signed and sealed construction documents be submitted for each permit application for all residential

SAFE ROOM INDUSTRY ORGANIZATIONS

For individuals interested in joining the expanding safe room market, industry and trade organizations can provide oversight and engineering evaluation programs for their members, which include safe room producers, installers, and other associated professionals. Producers, contractors, and firms that wish to indicate that their safe room products have been properly designed and tested should follow the requirements in ICC 500 Section 112, Listing and labeling.

storm shelters unless they are prefabricated units listed and labeled to demonstrate compliance with ICC 500. At the time this fifth edition of FEMA P-320 is being published, prefabricated storm shelter manufacturers are working with testing agencies and third-party certifiers to develop programs that will comply with the new requirements. Potential prefabricated safe room consumers should work with their State Emergency Manager and/or State Hazard Mitigation Officer (SHMO) as described in Section 4.3.3 to determine if they maintain information on compliant products, but labels similar to the one shown in Figure 4-1 should soon be available on prefabricated safe room units for verification purposes.

Another important consideration for prospective prefabricated safe room consumers (and building code officials) involves recognizing the limitations of storm shelter and safe room labels. Label marking requirements in ICC 500 only address missile impact and pressure testing compliance of the unit; other criteria, such as anchorage (described below) and nonstructural design requirements, are not covered by the labels. Therefore, consumers should request verification from prefabricated safe room manufactures that the safe room unit complies with all current ICC 500 and FEMA P-361 criteria. Although non-structural criteria for residential safe rooms are simpler than those for community safe rooms, they are still critical for occupant safety and comfort.

4.2.2 Anchorage

Prefabricated safe room units typically include the entire safe room with the exception of the foundation. Therefore, even if the prefabricated safe room has been tested, listed, and labeled for the missile impacts and wind pressures required by FEMA P-361 and ICC 500, the safe room must be installed on an adequate foundation. Many consumers are unaware of this and have prefabricated safe rooms installed on existing, unreinforced (or insufficiently reinforced) slabs, compromising the ability of the safe room to meet the life-safety protection standard. Similarly, in-ground prefabricated safe rooms have specific anchoring requirements intended to resist hydrostatic and uplift forces from saturated soils and rising groundwater that can push inadequately anchored units out of the ground.

Consumers should be aware of the necessity of a strong foundation and anchorage when choosing a safe room to avoid purchasing a safe room unit and installing it on an inadequate foundation. ICC 500 (Section 106.2) requires storm shelter construction documents to clearly show the minimum foundation capacity requirements, including foundation thickness, steel reinforcement, and minimum concrete cover as well as the locations and specifications for all storm shelter anchors. Additionally, ICC 500 requires a special inspection of anchors that are installed in hardened concrete (i.e., an existing slab). The purpose of these inspections is to verify that anchor installation, anchor capacity, and foundation adequacy are in accordance with the specified anchor's requirements. More information on prefabricated safe room installation needs for above- and in-ground units can be found in the *Foundation and Anchoring Criteria for Safe Rooms* Fact Sheet (FEMA, 2021d), which can be downloaded here: <https://www.fema.gov/emergency-managers/risk-management/safe-rooms/resources>.

Consumers may contact their local building official for assistance if they are unsure whether a safe room product is being properly installed on an adequate foundation, as well as for assistance in verifying whether a safe room product complies with the appropriate criteria. Additionally, as noted under “How to Use the Design Plans” in Section 5.2, the 2021 IRC specifies that

storm shelters are not exempt from building permit requirements as accessory structures. So even though the prefabricated storm shelter or safe room may serve as an accessory structure (e.g., garden shed) when not being used as a storm shelter or safe room, it still needs to be permitted to ensure installation complies with ICC 500 requirements for storm shelters as well as manufacturer-specific details.

4.3 Safe Room Cost

During the construction of a new home, the estimated basic cost to construct a safe room using the design plans in this publication ranges from approximately \$9,400 to \$13,100 for an 8-foot × 8-foot safe room and from \$18,900 to \$25,500 for a 14-foot × 14-foot safe room.⁶ The basic cost includes materials, labor and contingency⁷ but does not include the cost and installation of the safe room door assembly, which is addressed in the following section. Further, safe rooms installed in existing homes will be more expensive than those built as part of new construction. The cost of your safe room will vary depending on a variety of factors, including:

- Size of the safe room
- Safe room construction materials (CMU, concrete, wood, insulated concrete form [ICF])
- Type of foundation on which the house is built (refer to Section 3.7)
- Depth of footing; cost estimates are based on a minimum depth of 2 feet, 6 inches
- Your location within the United States⁸ (because of regional variations in labor and material costs)
- Whether you are building a safe room in a new home or retrofitting an existing home
- Any added amenities (e.g., bathroom fixtures)

4.3.1 Safe Room Door Assembly Cost

Prospective safe room owners are often surprised at the high cost of certified safe room door assemblies. Market research shows that entry level prices for properly tested and labeled residential safe room door assemblies are between approximately \$2,500 and \$3,200 at the time of this publication. These doors are significantly more expensive than regular door assemblies because the strength of the safe room door, hinges, latch and handle assembly, and connection of the door frame into the wall all require significant research and testing to develop a door system that will resist the wind pressures and wind-borne debris created by high-wind events. Failure of the door can mean the failure of the entire safe room, particularly for small, single-room safe rooms, where occupants taking refuge are in close proximity to the door and would be at great

⁶ These costs are estimated ranges for the design plans in this publication. Actual costs may vary as a result of regional variations in cost, changes in material or labor costs, or other factors. Estimates of safe room designs for each construction type were developed using industry-accepted cost-estimating guides and are provided in 2019 dollars. These values do not include amenities or any modifications or additional features not shown in the design plans

⁷ A contingency of 15% has been added to account for waste, miscellaneous hardware, accessories, and details.

⁸ Unit costs were derived from national averages obtained from RSMeans Building Construction Cost Data (2019). Your safe room contractor or RDP should be able to adjust estimated cost by applying regional factors based on your location.

risk if the door fails. A safe room that is otherwise designed to the life-safety criteria provided in FEMA P-361, but with a substandard door (one that does not meet the requirements discussed in Section 4.1.2), will not offer the same level of protection to occupants. Such safe rooms have resulted in serious injuries and even death in previous tornado events.

WARNING! SAFE ROOMS DOORS MUST BE LABELED

Only safe room doors that have been tested, listed, and labeled as compliant with the current versions of FEMA P-361 and ICC 500 for missile impact and wind pressure provide near-absolute protection. Using a non-compliant door can, and has, resulted in serious injury and death.

For more information, see FEMA's *Residential Tornado Safe Room Doors* Fact Sheet (FEMA, 2021c) at <https://www.fema.gov/emergency-managers/risk-management/safe-rooms/resources>.

4.3.2 Prefabricated Safe Rooms

Prefabricated safe rooms typically cost less than site-built safe rooms and are available in smaller sizes than those provided in the design plans of this publication. However, in addition to the base cost of the prefabricated unit, costs may also be incurred for delivery and any foundation or geotechnical work that may be required to install the safe room on an adequate foundation. Consider the following examples:

- A small (4-foot × 6-foot), above-ground prefabricated steel safe room that is shipped 300 miles and installed may retail for approximately \$5,800, but additional costs will be incurred to install a compliant supporting foundation. The average cost of site preparation is \$1,000, which includes a reinforced concrete slab for anchoring. As with site-built safe rooms, costs to install the safe room foundation are greater where an existing slab must be removed to install a more robust foundation.
- A heavier prefabricated unit with more square footage can reduce the need for foundation and geotechnical work as described in Section 3.3. A free-standing, exterior-sited, 6-foot × 6-foot precast concrete safe room may be installed for approximately \$5,700 (includes a 300-mile delivery fee and installation), because it only needs to be placed on stable soil or a typical concrete slab. However, to accomplish this, there needs to be a level stone or garage floor pad. The average cost for site preparation is \$100.
- In-ground safe room options are available in steel and precast concrete. As described in Section 3.6.3, in-ground safe rooms are typically installed outside of the house, but some models have been designed specifically to be installed below garage slabs. Small steel in-ground units typically cost between \$5,000 and \$6,000 not including installation (excavation and ground anchors) and delivery fee.

Different safe room producers have different limits on how far they will ship or deliver their products, and delivery charges typically vary as a function of distance from the producer's site. And as is the case with other freight, larger units will usually cost more to deliver than smaller ones. While consumers in and around "tornado alley" may have many prefabricated safe room options to choose from, other communities may be outside delivery zones for some producers. In such cases, it is recommended that you ask your SHMO (see Section 4.3.3 for contact information) if they are aware of any FEMA-compliant safe room producers that deliver to your area.

4.3.3 FEMA Safe Room Funding

Individual homeowners do not apply directly to FEMA for safe room funding, but if your state or local community's hazard mitigation plan addresses hurricane, tornado, or other wind hazards, then funding opportunities may be available. To find out about potential FEMA funding for safe rooms, contact your State Emergency Manager and/or SHMO. The listing of SHMOs can be found at <https://www.fema.gov/grants/mitigation/state-contacts>.

FEMA provides Hazard Mitigation Assistance (HMA) funding to eligible states, tribes, and territories that, in turn, provide the funding to local governments to assist in reducing overall risk to people and property. You can find information about various funding types on FEMA's "Safe Room Funding" webpage at <https://www.fema.gov/emergency-managers/risk-management/safe-rooms/funding>.

FEMA's HMA grants include Hazard Mitigation Grant Program (HMGP) funds and Building Resilient Infrastructure and Communities (BRIC) grant program funds. Funding may also be available from other sources such as United States Department of Housing and Urban Development Community Development Block Grant Funds and Federal Housing Administration Mortgage Insured Financing.

A SHMO can answer questions regarding project eligibility and financial assistance and provide detailed information on funding sources. The SHMO can also tell you what information must be provided for a safe room project to be considered for funding, as well as any applicable federal, state, and local design requirements.

Another resource for questions regarding safe room funding is FEMA's HMA Grants Helpline, which can be contacted by calling 1-866-222-3580.



5

Building Your Site-Built Safe Room

The safe room design plans in this publication were developed from FEMA P-361 design criteria for near-absolute protection from tornadoes and hurricanes and meet the criteria in ICC 500. The safe room sizes and materials specified in the plans are based on principles and practices used by structural engineering professionals and the results of extensive testing for the effects of missile impacts and wind pressures.

The prescriptive solutions are limited to specified sizes that range from 8 feet × 8 feet to 14 feet × 14 feet, both with a maximum wall height of 8 feet, and include material options for CMU, concrete, ICF, and wood frame with steel sheeting safe rooms. Regardless of the material type chosen, all FEMA P-320 design plans provide near-absolute protection to occupants of one- and two-family residences (i.e., buildings that fall under the scope of the IRC) if installed as specified.

Any alterations to the safe room design plans should undergo structural analysis by an RDP to determine whether the modified plans still meet the design criteria of FEMA P-361 or ICC 500 and are therefore acceptable, or if they must be redesigned to meet the design criteria. Additional guidance on design assumptions, construction limitations, and site-specific conditions that must be verified are included in Sections 5.2, 5.2.1, and 5.2.2.

As with earlier editions of FEMA P-320, your builder/contractor can use the design plans provided in this publication to build a safe room for your home. However, changes in the 2021 IRC (Section R323) and ICC 500 (Section 106.1) now require all residential storm shelter plans to bear the seal of an RDP unless the prefabricated shelter is listed and labeled for compliance with ICC 500 as described in the text box below. Therefore, while guidance in previous editions of this publication emphasized the importance of involving an RDP for site-specific implementation of the safe room design plans, signed and sealed construction documents are now required for compliance with ICC 500-2020 and to obtain FEMA funding for a site-built safe room. If you are not using FEMA funding,

WARNING! USE MATERIALS SPECIFIED

Be sure to use the exact types of materials specified in the design plans; otherwise death or injury could occur. Any changes need to be reviewed by an RDP to ensure the replacement would still result in near-absolute protection. It is imperative that materials ordered are double-checked to ensure they match the design plans. “Value engineering” should not be applied to the design plans.

check with your local code official to see which version of the building code is currently applicable in your area. If sealed design plans are not yet required by the applicable code and you are not seeking FEMA funding, then FEMA still strongly recommends that an RDP be involved in the project. Even when the design plans are used without modifications, an RDP is needed to verify conditions described in Section 5.2.1 and address any differences that may require enhanced specifications.

The attached safe room design plans include:

- General design notes and tables
- Design plans and details

If you or your builder/contractor has questions about the design plans in this publication, call the FEMA Safe Room Helpline at 1-866-927-2104 or email saferoom@fema.dhs.gov for technical guidance.

NEW CODE REQUIREMENT

Section R323 of the 2021 IRC has been updated to require that residential storm shelter construction documents be prepared and sealed by an RDP unless storm shelters are listed and labeled as ICC 500-compliant products, such as prefabricated storm shelter units.

Even when FEMA P-320 design plans are prepared and reviewed by an RDP to comply with ICC 500 and FEMA P-361, the plans should always be sealed by an RDP who carefully reviews this chapter and the design plans to verify the conditions specified in the design plans and described in this chapter are satisfied for the specific safe room project. If the design plans are modified or site conditions vary, then the RDP needs to reanalyze the design plans to determine whether compliance will still be achieved. If the analysis of the proposed modification or actual site conditions result in a finding of non-compliance, then the safe room will require redesign. Be advised that compliance with the latest edition of ICC 500 and FEMA P-361 is required for all FEMA-funded projects.

5.1 Design Plans Index

Table 5-1 identifies the sheet numbers and titles of safe room design plans included in this publication.

TABLE 5-1: DESIGN PLANS INDEX

Sheet #	Sheet Title
SR0.0	Index Sheet
SR0.1	ICC 500 Design Information Table
SR0.2	General Notes
SR0.3	General Notes
SR0.4	Tables
SR1.0	CMU Safe Room Plans and Details
SR1.1	Concrete Safe Room Plans and Details
SR1.2	ICF Safe Room Plans and Details
SR1.3	Wood Frame Safe Room Plans and Details
SR1.4	Details for Safe Rooms That Use Basement Walls
SR2.1	Safe Room Sheathing Requirements
SR2.2	Safe Room Opening Requirements

5.2 How to Use the Design Plans

Follow the guidelines below when using the design plans included in this publication.

- The design plans provided in this publication are not intended to be a substitute for the involvement of an RDP. Given the requirements in ICC 500-2020 and the 2021 IRC, the intended function of these structures, and site-specific conditions that need to be addressed, FEMA recommends that an RDP be involved. For FEMA-funded projects, plans will require review and seals from an RDP.
- Sheet SR0.1 includes the ICC 500 Design Information Table (adapted from ICC 500, Sections 106.2.1 and 106.2.2), which is required to be filled out and provided with the construction documents submitted to the AHJ for permits. Design information needed to engineer the prescriptive solutions is already provided on the design plans. However, most of the design information is project-specific and needs to be completed by the RDP who reviews the plans and this chapter to verify that the chosen safe room plan has not been modified and that conditions for the construction site have been verified to be within the limitations specified in the design plans and described in this chapter. A verification statement is provided on Sheet SR0.0 for the RDP to seal.
- Sheet SR0.0 also provides safe room design option prompts to indicate which safe room plans and details (SR1.1 – SR1.4) will be constructed, the outer dimensions of the safe room, and which roof type (wood frame or concrete) will be constructed. This information, along with the information indicated in the previous bullet, will facilitate plan review, permitting, and inspections.
- If the design plans are modified or site conditions are found to be outside the limitations described in this chapter and the design plans, then structural analysis is required to determine whether the original specifications still meet the minimum design criteria in ICC 500-2020 (and FEMA P-361 [FEMA, 2021a] if constructed with FEMA funds). If the analysis results in a determination of non-compliance, the plans will need to be redesigned and sealed by the RDP in responsible charge.
- Prospective owners of safe rooms may want to consider amenities that are not covered in the design plans but that would add measures of convenience to the safe room. These include plumbing, power outlets (to keep phones charged or plug in a weather radio, for example), installed lighting, or cables for internet and landline phones, among other items. If these amenities result in penetrations of the safe room walls or roof that cannot be accommodated by the system detailed on Sheet SR2.2 for individual ventilation openings, then an impact protective system that complies with ICC 500 Section 306.4.1 will need to be installed. Safe room mechanical, electrical, and plumbing penetrations typically require custom-sized impact protective systems (e.g., steel shields and cowlings) designed to be anchored to surround the wall or roof system by structural engineers who specialize in safe room design.
- The maximum nominal panel size for the egress door is 3 feet wide × 7 feet tall. For wood-framed safe rooms, the egress door must be installed in the longest wall. Refer to “Door Notes” on Sheet SR0.2 for additional plan specifications; guidance on safe room door labeling may be found in Section 4.1.2.

- Determine the flood siting and elevation requirements for your safe room (see Section 3.2 for more information, as well as the FEMA Fact Sheet, *Flood Hazard Siting and Elevation Criteria for Residential Safe Rooms* [FEMA, 2021b], which may be downloaded from <https://www.fema.gov/emergency-managers/risk-management/safe-rooms/resources>).
- The sizing of the safe room (for plan outer dimensions) may range from 8 feet × 8 feet to 14 feet × 14 feet, with any combination therein (the maximum ratio of width to length is 8 feet × 14 feet). Note that inner dimensions will differ depending on the material type selected.
- Determine the number of occupants and size of the safe room (see Section 3.4 for floor space required per occupant). Using this information, determine the required ventilation at 4 square inches per person for hurricane residential safe rooms and 2 square inches per person for tornado residential safe rooms (see Sheet SR2.2 in the design plans for more information).
- The safe room design plans were developed for a maximum wall height of 8 feet; higher walls will require structural analysis, which may trigger a requirement to redesign. Minimum wall heights should be determined by the 2021 IRC. Ease of access, as well as duration of occupancy and level of occupant comfort, should be considered.
- In accordance with ICC 500 Section 508.2, all storm shelters (including all safe rooms) are required to include signage indicating:
 1. The storm shelter design occupant capacity (refer to Section 3.4 of this publication; verify with RDP).
 2. The storm type (tornado or hurricane).
 3. The storm shelter design wind speed (250 mph for all residential safe rooms).
 4. The edition of ICC 500 used for the design (this publication corresponds to ICC 500-2020).
 5. The name of the manufacturer or builder of the shelter.

Consequently, when you select your safe room type and size, you should indicate on the floor plan where your design information sign will be located.
- Design plans should not be scaled to determine dimensions. If the needed dimension is not specified, then please contact the FEMA Safe Room Helpline at saferoom@fema.dhs.gov or 1-866-927-2104.
- Because not all contractors are familiar with the type of structural connectors shown in the plans, the names of two companies that manufacture connectors have been included in the Connector Schedule on Sheet SR0.4 of the design plans. However, the list of companies is not exhaustive. Additionally, this list is not intended to express a preference for those manufacturers or their products by the U.S. Government, nor is it an endorsement of those manufacturers or their products.
- Before construction begins, **all necessary building permits should be obtained**. The 2021 IRC specifies in Section R105.1 that storm shelters (which include safe rooms) are not exempt from building permits even when their alternate use would normally be considered accessory to the building(s) they serve. The homeowner or contractor (or RDP if applicable)

should meet with the local code official to discuss any concerns the building official may have regarding the safe room design.

- If the design plans conflict with local codes, the more conservative criteria should govern. If this occurs, an RDP in the state in which the safe room is to be installed should analyze the conflict and design alterations if needed to ensure compliance with the current edition of FEMA P-361.
- Please note that state and local jurisdictions may have requirements that are more stringent than FEMA's guidance and recommendations. As with all design and construction matters, please work with the local building department and all other AHJs to ensure that ALL state and local requirements are being met, even when using FEMA recommendations. Consult an RDP if modifications are made to these plans to verify that the modified plans still meet or exceed the design criteria of FEMA P-361.

5.2.1 Site Conditions Requiring Verification

The design plans included in this publication meet FEMA P-361 residential safe room criteria as reflected in the Design Criteria listed on Sheet SR0.3. However, site-specific conditions for any given safe room may differ from the assumed site conditions and loads used to develop the prescriptive safe rooms presented in this document. The following conditions will need to be verified by an RDP to ensure the prescriptive safe room specifications satisfy your site-specific installation. Where any condition is not met or design load assumptions are exceeded, analysis will be needed to determine if specifications should be enhanced to comply with FEMA P-361. Have an RDP verify that:

- The safe room is not sited in an SFHA. If sited within an SFHA, then refer to Section 3.2.1 to determine whether siting is restricted. If siting is not restricted, then the elevation of the safe room floor should meet the criteria in Section 3.2.2. Special foundation design will be needed where the finished floor elevation of the safe room is 5 feet or more above the lowest finished adjacent grade.
- No laydown hazard or falling debris hazards are present. Refer to ICC 500 Section 305.3 for details.
- Roof snow loads for the site do not exceed 100 psf where the safe room is installed on the exterior of the house.
- Roof live loads do not exceed 100 psf where the safe room is installed inside the house. The anticipated roof live load should account for debris that could accumulate on the safe room roof when the host building is destroyed by an extreme wind incident. The roof live load is likely to exceed 100 psf where more than two stories or heavy building materials or equipment are present above the safe room.
- The Seismic Design Category is A or B only; see Section 5.2.2 for guidance where the Seismic Design Category is C, D, or E.
- The minimum soil bearing capacity is 1,500 psf; refer to the Foundation Notes on Sheet SR0.3 and Slab-on-Ground General Notes on Sheet SR0.2 for additional requirements.

Please note that the checklist above is intended to highlight critical design assumptions needing verification prior to permitting and construction. As with all construction projects, safe room design plan users should carefully review all notes that are included on Sheets SR0.2 and SR0.3 (excluding material options not implemented).

5.2.2 Seismic Risks

In some locations around the United States, the risk of seismic events may be substantial enough that the building code may require seismic detailing to be on the plans, and may even create a situation where the code-required seismic loads would be greater than the wind loads applied to the safe room. This could trigger additional requirements for wall reinforcement, connection details, and foundations, and the need to prepare a geotechnical report. For residential safe rooms located in Seismic Design Categories C, D, and E on the maps shown in Figure 5-1, you will need to consult an RDP about seismic loads and any required detailing on the plans. The RDP who analyzes the safe room structural design to include site-specific seismic loading should be licensed in the state or territory where the safe room will be installed and, if necessary, make any modifications to ensure that the chosen safe room design meets or exceeds the design criteria in FEMA P-361. The United States island territories of Puerto Rico, United States Virgin Islands, Guam, Commonwealth of the Northern Mariana Islands, and American Samoa are not included on the maps in this publication because all inhabited islands are designated as Seismic Design Categories C, D, or E, and therefore need to be analyzed for seismic loading.

Keep in mind as you consider your risk to seismic activity that locally adopted codes may have varying requirements. As with all design and construction matters, you should work with your local building department and all other AHJs to ensure that all state and local requirements are being met, even when using FEMA publication and guidance recommendations.

ALTERNATE SEISMIC PROVISIONS

In addition to the seismic risk maps shown in Figure 5-1, the 2021 IRC includes Alternate Seismic Design Category maps. This map set was developed to allow a possible reduction in assigned Seismic Design Category when additional soils information is available. Because some building departments have knowledge of soil types, they can identify areas within the jurisdiction where use of the alternate maps is acceptable. Where soils (geotechnical) reports are present, this determination could also be made on a site-by-site basis.

5.3 Other Options

In addition to the safe room design plans in this publication, there are other site-built storm shelter and safe room options available. As always, an RDP should verify that these other alternatives meet or exceed FEMA P-361 criteria.

When following guidelines or designs by others, be advised that FEMA-funded residential safe rooms and safe room products (e.g., door assemblies, foundation anchoring, and openings) are required to meet criteria associated with the 250 mph safe room design wind zone and flood siting and elevation requirements outlined in Section 3.2 of this document.

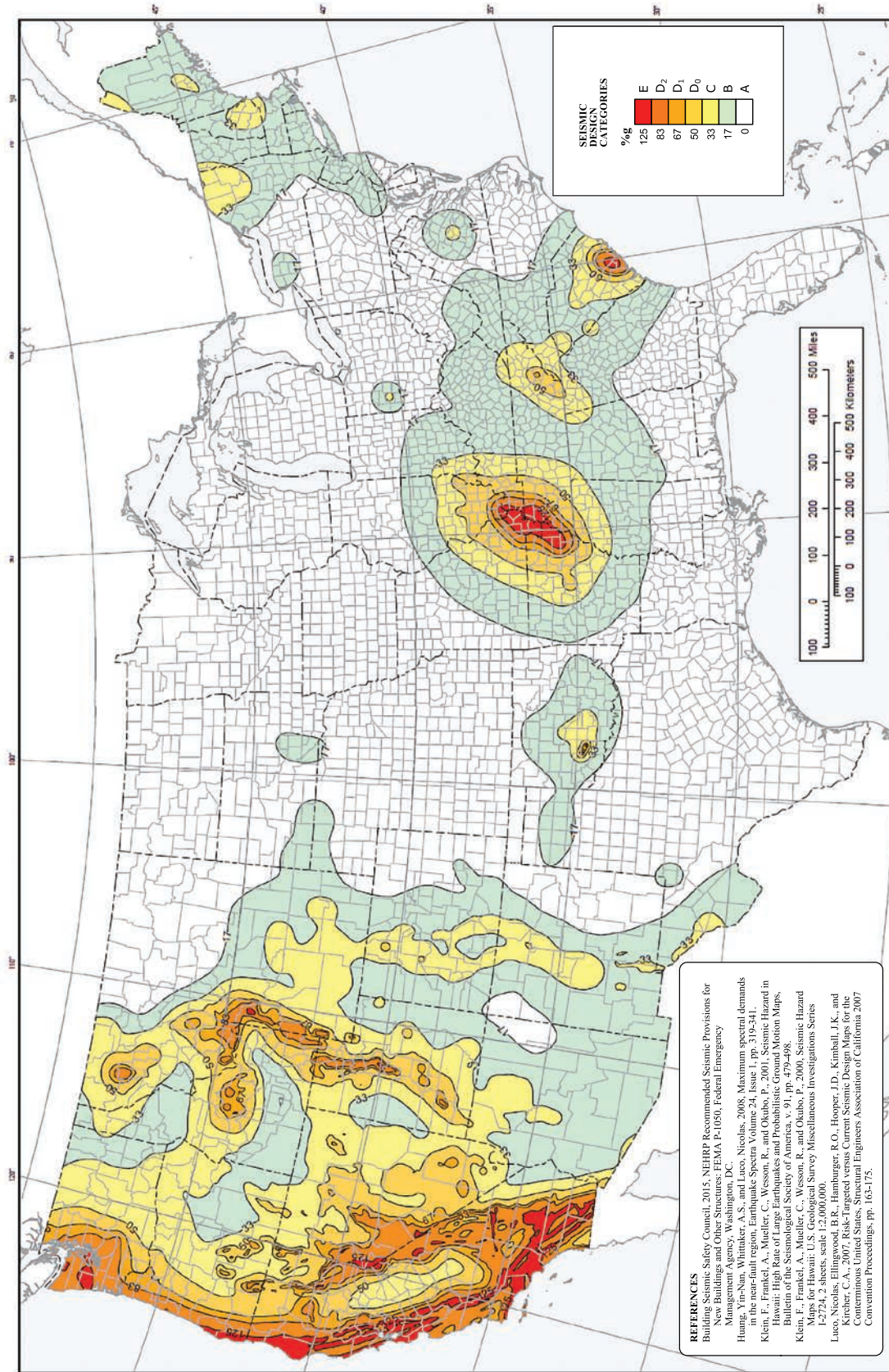

Figure 5-1: Seismic Risk Map*

SOURCE: FEMA P-1050

* This map is based on Site Class D soil. Seismic Design Categories have been adapted into ranges of risk for the purpose of verifying the seismic risk for safe rooms. "High" corresponds to Seismic Design Categories D and E, "moderate" corresponds to Seismic Design Category C, and "low" corresponds to Seismic Design Categories A and B. To access the original map (with Seismic Design Categories and ground acceleration values), see FEMA P-1050 or the 2021 IRC.

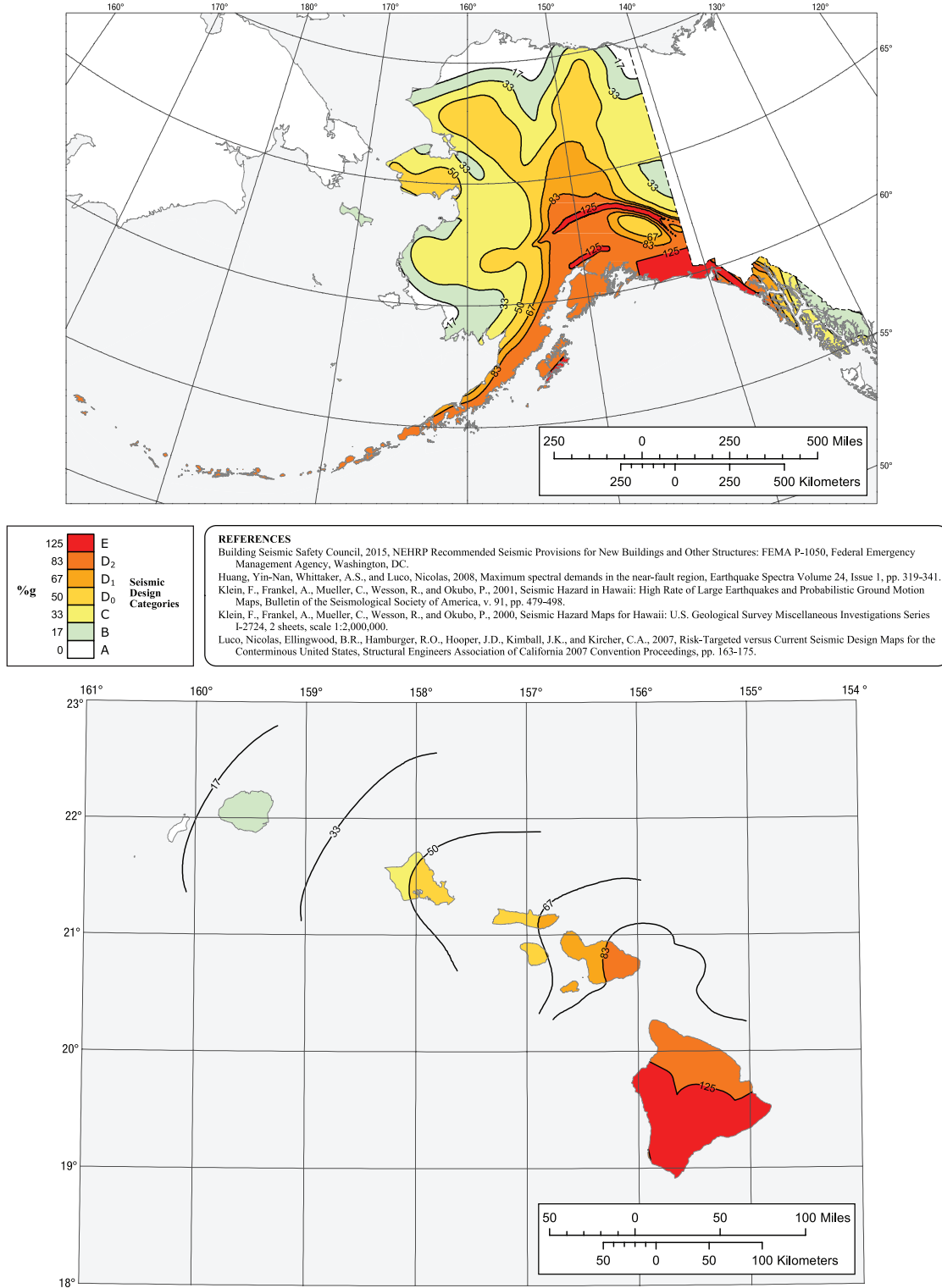

Figure 5-1: Seismic Risk Map*

SOURCE: FEMA P-1050

* This map is based on Site Class D soil. Seismic Design Categories have been adapted into ranges of risk for the purpose of verifying the seismic risk for safe rooms. “High” corresponds to Seismic Design Categories D and E, “moderate” corresponds to Seismic Design Category C, and “low” corresponds to Seismic Design Categories A and B. To access the original map (with Seismic Design Categories and ground acceleration values), see FEMA P-1050 or the 2021 IRC.

6

Additional Resources, Emergency Planning and Supply Kit, and References

This chapter provides additional resources for safe rooms, as well as guidance for emergency planning. This emergency planning guidance can be used whether or not your home has a safe room. A checklist for an emergency supply kit is also provided. The final section of this chapter is a list of references.

6.1 Additional Resources

For any questions on safe rooms, contact the FEMA Safe Room Helpline by email at saferoom@fema.dhs.gov or by calling 1-866-927-2104. For questions on any other FEMA Building Science publications, contact the FEMA Building Science Helpline by email at FEMA-buildingsciencehelp@fema.dhs.gov or by calling 1-866-927-2104. Free hard copies of FEMA Building Science's current publications may also be ordered by calling the FEMA Publication Warehouse at 1-800-480-2520, Monday through Friday between 8:00 AM and 5:00 PM (EST), by fax at 1-719-948-9724, or by emailing your request to FEMApubs@gpo.gov. Please provide the title, publication number, and quantity of each publication, along with your name, address, zip code, and daytime telephone number.

Each of FEMA's safe room resources and fact sheets can be found online at <https://www.fema.gov/safe-rooms>.

If you are interested in getting information regarding obtaining a grant for safe room construction, please contact the HMA Grants Helpline by calling 1-866-222-3580 or visit FEMA's "Safe Room Funding" webpage at <https://www.fema.gov/safe-room-funding>.

You can also find helpful resources at <https://www.ready.gov/>, a website dedicated to preparedness maintained by the U.S. Department of Homeland Security. Hurricane- and tornado-specific documents on Ready.gov include suggested emergency supply kits, food, and water; staying informed about alerts; and making a plan to protect your family, among many other topics.



Additional material has been developed in recent years and will likely continue to be propagated, such as the Federal Alliance for Safe Homes (FLASH) outreach efforts that can be found on www.FLASH.org. These materials include promotional videos, animations, online courses, a hurricane emergency supply kit, and additional outreach material.

6.2 Emergency Planning and Emergency Supply Kit

Whether or not you need a safe room in your home, you can take two important steps to protect yourself and your family during a hurricane or tornado: prepare an emergency plan and put an emergency supply kit together. You should either keep your emergency supply kit in your safe room or be ready to bring it with you if you need to evacuate your home. A checklist of some suggested items to include in an emergency supply kit is provided on the following page. Remember to regularly maintain your emergency supply kit by ensuring proper storage of food (keep goods in a cool, dry location; any non-canned items should be stored in tightly closed plastic or metal containers) and materials, replacing any expired items, and regularly updating your supplies as your family's needs change.

Additionally, remember that after an extreme-wind event the egress from a safe room may be blocked. Therefore, if you decide to build a safe room, your emergency plan should include notifying local emergency managers, first responders (local fire stations), and family members or others outside the immediate area that you have a safe room. This should be done by registering the precise coordinates (latitude and longitude) of the entrance to the safe room with your local officials (note that this should be done right after the safe room is constructed, rather than waiting until an extreme-wind event is imminent). This will allow emergency personnel to find and quickly free you after the storm if the exit from your safe room becomes blocked by debris. Tools to open or dismantle the door from the inside and an alternate means of communication should also be kept in the safe room.

First aid kits are strongly recommended for all residential safe rooms. For tornadoes, the kits are needed because injuries frequently occur as occupants rush to safety with short warning times. On the other hand, hurricane safe rooms are typically occupied for 24 hours or longer, and injuries can occur while the safe room is locked down.

EMERGENCY SUPPLY KIT

For Both Tornado and Hurricane Residential Safe Rooms

WATER & FOOD:

- An adequate supply of water for each occupant (1 gallon per person per day; 3-day supply for hurricane and 1-day supply for tornado)
- Enough non-perishable foods that do not have to be prepared or cooked for the safe room rated occupancy (if these include canned goods, remember to include a manual can opener) (3-day supply for hurricane, 1-day supply for tornado)
- Disposable eating utensils, plates, cups, paper towels, etc.

MEDICAL:

- First-aid kit
- Necessary prescription medicines or other medical equipment
- Bandages
- Antibiotic ointment
- Emergency reference material such as a first aid book or information from [Ready.gov](https://www.ready.gov)

TOOLS:

- Flashlight (at least one per every 4 potential occupants)
- Battery-operated radio and NOAA* Weather Radio
- Cellular phone or Citizens Band radio
- Extra batteries and chargers for these devices
- Wrench or pliers (to turn off gas and water)
- Tools to open damaged doors (e.g., a crowbar, jack, spreader)

PERSONAL:

- Personal hygiene items such as hand wipes/hand sanitizer and toilet paper
- Portable chemical-type toilet receptacle
- Moist towelettes, garbage bags, and plastic ties (for personal sanitation)
- Feminine supplies and personal hygiene items
- Extra change of clothing per person (store in plastic trash bags to keep clean and dry)
- Appropriate outer wear (sunglasses, ponchos, jackets, gloves, headwear, boots, etc.)
- Bedding materials such as pillows and blankets or sleeping bags for each person (Note: Safe room size may limit this)

SPECIAL ITEMS:

- Babies – formula, diapers, bottles, powdered milk for 3 days
- Adults – contact lenses and supplies, extra glasses, and a sufficient supply of prescription medications
- Pets – appropriate supplies such as water, food, leash, ID and rabies tags, carrying container, etc.

ADDITIONAL ITEMS:

- Children – entertainment items such as books, games, or toys (discretionary)
- Important documents such as insurance documents, a list of all your important contacts (e.g., family, doctors, insurance agents), banking information, leases/mortgage, proof of occupancy (such as a utility bill), and a waterproof container in which to keep these documents
- Paper and pencil (discretionary)
- ABC-rated** fire extinguisher
- Dust masks to help filter contaminated air
- Roll of large heavy-duty trash bags and ties
- Money (cash)
- An audible sounding device that continuously charges or operates without a power source (e.g., canned air horn or whistle) to signal rescue workers if safe room egress is blocked, and hearing protection (e.g., ear plugs or ear muffs) for each occupant
- Household chlorine bleach and medicine dropper***
- Matches in a waterproof container
- Local maps

ADDITIONAL FOR HURRICANE ONLY

- Insect repellent and sunscreen
- Roofing tarps or plastic sheeting and duct tape to shelter-in-place after the storm

* The NOAA Weather Radio (NWR) is a nationwide network of radio stations broadcasting continuous weather information directly from a nearby NWS office. NWRs broadcast NWS warnings, watches, forecasts, and other hazard information 24 hours a day, as well as post-event information for all types of hazards, both natural and technological. NWRs are available at electronics stores across the country and range in cost from \$25 to \$100 or more, depending on the quality of the receiver and number of features. The NWS does not endorse any particular make or model of receiver. For more information on what to look for in a weather radio, please see Recovery Advisory 5, “Critical Facilities Located in Tornado-Prone Regions: Recommendations for Facility Owners,” of FEMA P-908. Available at https://rems.ed.gov/docs/Critical_Facilities_TornadoProneAreas.pdf.

** ABC refers to fires originating from three types of sources: A – paper, wood, or fabric; B – gasoline or oil; or C – electrical.

*** When diluted to nine parts water to one part bleach (regular, unscented), bleach can be used as a disinfectant, or in an emergency, you can use it to treat water by using 16 drops of regular household liquid bleach (regular, unscented) per gallon of water.

6.3 References

- ACI (American Concrete Institute). 2014. *Residential Code Requirements for Structural Concrete and Commentary* (332-14). <https://www.concrete.org/store/productdetail.aspx?ItemID=332U14&Language=English>.
- ACI. 2019. *Building Code Requirements for Structural Concrete and Commentary* (ACI 318). <https://www.concrete.org/tools/318buildingcodeportal.aspx.aspx>.
- ASCE (American Society of Civil Engineers). 2010. *Minimum Design Loads For Buildings and Other Structures* (ASCE 7-10). Structural Engineering Institute. Available at <https://ascelibrary.org/doi/book/10.1061/9780784412916>.
- ASCE. 2014. *Flood Resistant Design and Construction* (ASCE 24-14). Available at <https://sp360.asce.org/PersonifyEbusiness/Merchandise/Product-Details/productId/233129242>.
- ASCE. 2016. *Minimum Design Loads and Associated Criteria for Buildings and Other Structures* (7-16), Available at <https://www.asce.org/structural-engineering/asce-7-and-sei-standards/>.
- FEMA. 2011a. *Coastal Construction Manual* (FEMA P-55). Available at https://www.fema.gov/media-library-data/20130726-1510-20490-2899/fema55_voli_combined.pdf.
- FEMA. 2011b. Recovery Advisory 5, “Critical Facilities Located in Tornado-Prone Regions: Recommendations for Facility Owners,” FEMA P-908. https://rems.ed.gov/docs/Critical_Facilities_TornadoProneAreas.pdf.
- FEMA. 2012. *Mitigation Assessment Team Report – Spring 2011 Tornadoes: April 25-28 and May 22* (FEMA P-908). Available at https://www.fema.gov/sites/default/files/2020-08/fema_p-908_tornado-mat-combined.pdf.
- FEMA. 2019. *2017 Hurricane Season Mitigation Assessment Team Compendium Report: Building Performance Observations, Recommendations, and Technical Guidance* (FEMA P-2054) September 2019. https://www.fema.gov/sites/default/files/2020-07/mat-report_2017-hurricane-season.pdf.
- FEMA. 2021a. *Safe Rooms for Tornadoes and Hurricanes: Guidance for Community and Residential Safe Rooms* (FEMA P 361). Available at <https://www.fema.gov/emergency-managers/risk-management/safe-rooms/resources>.
- FEMA. 2021b. Fact Sheet, *Flood Hazard Siting and Elevation Criteria for Residential Safe Rooms*. <https://www.fema.gov/emergency-managers/risk-management/safe-rooms/resources>.
- FEMA, 2021c. Fact Sheet, *Residential Tornado Safe Room Doors*. <https://www.fema.gov/emergency-managers/risk-management/safe-rooms/resources>.
- FEMA. 2021d. Fact Sheet, *Foundation and Anchoring Criteria for Safe Rooms*. <https://www.fema.gov/emergency-managers/risk-management/safe-rooms/resources>.
- ICC/NSSA (International Code Council/National Storm Shelter Association). 2020. *ICC/NSSA Standard for the Design and Construction of Storm Shelters* (ICC 500). Available at <https://codes.iccsafe.org/content/ICC5002020P1>.

- IRC (International Residential Code). 2021. *International Residential Code for One- and Two-Family Dwellings*. Available at <https://codes.iccsafe.org/content/IRC2021P1>.
- KWTV, 2015. "Understanding storm shelters could save Oklahomans' lives." News on 6. Available online at <http://www.newson6.com/story/29010877/understanding-storm-shelters-could-save-oklahomans-lives>.
- Nielsen, Erik R., Gregory R. Herman; Robert C. Tournay; John M. Peters; and Russ S. Schumacher. "Double Impact: When Both Tornadoes and Flash Floods Threaten the Same Place at the Same Time," *Weather and Forecasting*. Volume 30, Issue 6, December 2015. <https://journals.ametsoc.org/waf/article/30/6/1673/40281/Double-Impact-When-Both-Tornadoes-and-Flash-Floods>.
- NIST (National Institute of Standards and Technology). 2014. *Final Report, National Institute of Standards and Technology Investigation of the May 22, 2011, Tornado in Joplin, Missouri*. Available at <http://dx.doi.org/10.6028/NIST.NCSTAR.3>.
- NOAA (National Oceanic and Atmospheric Administration), NCEI (National Centers for Environmental Information) National Severe Weather Database. Undated. <http://www.ncdc.noaa.gov>. Accessed September 23, 2020.
- NOAA National Climatic Data Center, Storm Events Database. 2020. <http://www.ncdc.noaa.gov/stormevents/>. Accessed September 25, 2020.
- NOAA NHC. Undated. Saffir-Simpson Hurricane Wind Scale <http://www.nhc.noaa.gov/aboutsshws.php>. Accessed September 25, 2020.
- NOAA NSSL (National Severe Storms Laboratory). Undated. Severe Weather 101: Damaging Winds Basics. <https://www.nssl.noaa.gov/education/svrwx101/wind/>. Accessed September 25, 2020.
- NOAA National Weather Service. 2020. Weather Related Fatality and Injury Statistics. <https://www.weather.gov/hazstat/>. Accessed December 16, 2020.
- NOAA National Weather Service, Storm Prediction Center. 2019. Severe Weather GIS (SVRGIS). <http://www.spc.noaa.gov/gis/svrgis/>. Accessed September 25, 2020.
- NOAA National Weather Service Storm Prediction Center. 2020. <https://www.spc.noaa.gov/>. Accessed September 25, 2020.
- RSMMeans. 2018. *Building Construction Costs with RSMMeans Data 2019*. Publisher: Gordian.

Appendix A: Acknowledgments

FEMA would like to acknowledge and thank the many people whose valuable contributions enabled this important update of FEMA P-320 to its fifth edition.

Stuart Adams, Stantec Consulting Services Inc.

American Society of Civil Engineers

Maryam Asghari Mooneghi, PE, PhD, AECOM

Michelle Guymon Barbee, Safe Sheds, Inc. and National Storm Shelter Association

Daniel Bass, RA, CFM, FEMA Headquarters

James Bell, Assa Abloy Group

Laurie Bestgen, CFM, FEMA Region VII

Harold Brooks, NOAA/National Severe Storms Laboratory

Young Cho, AECOM

Carol Cook, AECOM, 508-Compliance

Anne Cope, Ph.D., PE, Insurance Institute for Business & Home Safety

Tom Curry, MiTek Inc.

Cooper Dull, Toth & Associates, Design Plans CAD Technician

Gary Ehrlich, PE, National Association of Home Builders

Jamie Farny, Portland Cement Association

Gina Filippone, CFM, AECOM

Christine Gaynes, FEMA Region V

Laura Ghorbi, PE, CFM, AECOM

Jennifer Goldsmith-Grinspoon, FEMA Headquarters, Project Lead

Todd Grevious, PE, MiTek Inc.

Andrew Herseth, PE, SE, FEMA Headquarters

Betsy Hicks, PE, CFM, AECOM

International Code Council

Christopher P. Jones, PE, Durham, NC

Samantha N. Krautwurst, PE, AECOM, Project Manager and Publication Manager

James G. LaDue, National Weather Service

Donald L. Leifheit Jr., CFM, FEMA Region VI

Philip Line, PE, American Wood Council
Lee-Ann Lyons, AECOM, Graphic Design Team Lead
Patrick Marsh, National Weather Service
Rachel Minnery, FAIA, American Institute of Architects
Kirsty Morgan, FEMA Region VII
Brian O'Connor, PE, CFM, CDM Smith
Brian Orr, PE, Toth & Associates, Design Plans Lead
Glenn Overcash, PE, AECOM, Project Manager and Technical Lead
Susan Ide Patton, PG, AECOM, Technical Editing Team Lead
Manuel Perotin, PE, CFM, CDM Smith
John “Bud” Plisich, FEMA Region IV
Stephen J. Raskin, AIA, FGM Architects
Adam Reeder, PE, CFM, CDM Smith
Tim Reinhold, PE, Stantec Consulting Services Inc.
Billy Ruppert, AECOM, Graphic Designer
Corey Schultz, AIA, LEED AP BD+C, Schultz² Architects, LLC
Pataya Scott, EIT, FEMA Headquarters, Project Lead
Randy Shackelford, PE, Simpson Strong-Tie Company, Inc.
Amy Siegel, AECOM, Technical Editor
David Stammen, PDE, UL LLC
Michelle Terry, AECOM
E. Scott Tezak, PE, BSCP, Atkins
Casey Thomas, International Code Council
Jason Thompson, National Concrete Masonry Association
Steve Trill, Toth & Associates, Design Plans CAD Technician
Mike Vaughn, Vaughn Concrete Products, Inc. and National Storm Shelter Association
Richard F. Walker Jr., PE, AECOM
Brian Willsey, FEMA Headquarters
Mariam Yousuf, FEMA Region IV
Darievus ZaGara II, Creative Engagement Solutions



FEMA

FEMA P-320 SAFE ROOM DESIGN PLANS TAKING SHELTER FROM THE STORM: BUILDING A SAFE ROOM FOR YOUR HOME

Second Printing of Design Plans

FEMA P-320 SAFE ROOM DESIGN PLANS SHEET LIST	
SHEET #	SHEET TITLE
SR0.0	INDEX SHEET
SR0.1	ICC 500 DESIGN INFORMATION TABLE
SR0.2	GENERAL NOTES
SR0.3	GENERAL NOTES
SR0.4	TABLES
SR1.0	CMU SAFE ROOM PLANS AND DETAILS
SR1.1	CONCRETE SAFE ROOM PLANS AND DETAILS
SR1.2	ICF SAFE ROOM PLANS AND DETAILS
SR1.3	WOOD FRAME SAFE ROOM PLANS AND DETAILS
SR1.4	DETAILS FOR SAFE ROOMS THAT USE BASEMENT WALLS
SR2.1	SAFE ROOM SHEATHING REQUIREMENTS
SR2.2	SAFE ROOM OPENING REQUIREMENTS

LIMIT OF LIABILITY

THE DESIGNS IN THIS BOOKLET ARE BASED ON EXTENSIVE RESEARCH OF THE CAUSES AND EFFECTS OF WINDSTORM DAMAGE TO BUILDINGS. SAFE ROOMS DESIGNED AND BUILT TO THESE STANDARDS SHOULD PROVIDE A HIGH DEGREE OF OCCUPANT PROTECTION DURING EXTREME WINDSTORMS (TORNADOES AND HURRICANES). ANY SUBSTITUTION OF EITHER MATERIALS OR DESIGN CONCEPTS MAY DECREASE THE LEVEL OF OCCUPANT PROTECTION AND/OR INCREASE THE POSSIBILITY OF PERSONAL INJURY DURING A SEVERE WIND EVENT.

BECAUSE IT IS NOT POSSIBLE TO PREDICT OR TEST ALL CONDITIONS THAT MAY OCCUR DURING SEVERE WINDSTORMS OR CONTROL THE QUALITY OF CONSTRUCTION AMONG OTHER THINGS, THE DESIGNER DOES NOT WARRANT THE DESIGN.

THE DESIGNER NEITHER MANUFACTURES NOR SELLS SAFE ROOMS BUILT FROM THESE DESIGNS. THE DESIGNERS HAVE NOT MADE AND DO NOT MAKE ANY REPRESENTATION, WARRANTY, OR COVENANT, EXPRESS OR IMPLIED, WITH RESPECT TO THE DESIGN, CONDITION, QUALITY, DURABILITY, OPERATION, FITNESS FOR USE, OR SUITABILITY OF THE SAFE ROOM IN ANY RESPECT WHATSOEVER. THE DESIGNERS SHALL NOT BE OBLIGATED OR LIABLE FOR ACTUAL, INCIDENTAL, CONSEQUENTIAL, OR OTHER DAMAGES OF OR TO USERS OF THE SAFE ROOM, OR ANY OTHER PERSON OR ENTITY ARISING OUT OF OR IN CONNECTION WITH THE USE, CONDITION, AND/OR PERFORMANCE OF THE SAFE ROOM BUILT FROM THIS DESIGN OR FROM THE MAINTENANCE THEREOF.

- I HAVE REVIEWED THE DESIGN PLANS, CHAPTER 5 OF FEMA P- 320, AND SITE CONDITIONS FOR THE SAFE ROOM PROJECT AND HAVE VERIFIED THAT THE PROPOSED SAFE ROOM DESIGN IS WITHIN THE LIMITATIONS SPECIFIED THEREIN.

- SAFE ROOM DESIGN OPTIONS.

- SAFE ROOM DRAWING NO: _____
- OUTSIDE DIMENSION OF PROPOSED SAFE ROOM: _____ X _____.
- FOR CMU, CONCRETE, AND ICF SAFE ROOM DESIGNS:
CONCRETE ROOF _____ OR WOOD FRAME ROOF _____

FEMA P-320 (2021)
Second Printing of Design Plans

SHEET TITLE: INDEX SHEET

DRAWING NO: SR0.0 Sheet: 1 of 12

DATE: OCTOBER 2021



FEMA

Copyright ©2021

DESIGN INFORMATION CATEGORY IN ACCORDANCE WITH ICC 500-20 SECTION 106.2.1 & 106.2.2	DESIGN INFORMATION	GUIDANCE FOR PROJECT-SPECIFIC DESIGN INFORMATION
1. Type of <i>storm shelter</i>	Residential	
2. Use of community storm shelter	N/A	
3. A statement that the design conform to the provisions of the ICC 500 Standard for the Design and Construction of Storm Shelters, with the edition year specified	Ref Design Criteria on Drawing No. SR0.3	
4. The <i>storm shelter design wind speed</i> , V_T , V_H , or both, mph (m/s)	$V_T=250$ mph	
5. The wind exposure category (indicate all if where more than one is used)	C	
6. The internal pressure coefficient, GC_{pi}	+/-0.55	
7. The topographic factor, K_{zt}	1.0	
8. The directionality factor, K_d	1.0	
9. <i>Design wind pressures</i> and their applicable zones with dimensions needed for the specification of the components and cladding of the <i>storm shelter envelope</i> , psf (kN/m ²)		For residential tornado safe room doors, Reference Design Wind Pressures Table and Figure on Drawing No. SR2.2
10. Where the storm shelter is subject to the requirements of Section 402.1, a statement that the <i>storm shelter</i> has/ or has not been constructed in accordance with Chapter 4		Reference FEMA P-320 Section 3.2 or FEMA P-361 (2021) Section B4.2.3
11. Where the storm shelter is subject to the requirements of Section 402.1, the minimum elevation of the lowest floor required by the <i>authority having jurisdiction</i> for the location where the <i>storm shelter</i> is installed; the <i>base flood elevation</i> , <i>500-year flood elevation</i> and <i>storm surge flood elevation</i> where applicable; and the storm shelter floor elevation. Where National Hurricane Center's <i>Sea, Lake and Overland Surges from Hurricanes</i> (SLOSH) or other <i>approved</i> source is utilized for data, the construction documents shall indicate the version, date and the source of the maps		Reference FEMA P-320 Section 3.2 or FEMA P-361 (2021) Section B4.2.3
12. Documentation showing that components of the <i>storm shelter envelope</i> will meet the static and cyclic pressure and impact test requirements identified in Chapters 3 and 8.		Reference FEMA P-320 Section 4.2.1 or FEMA P-361 (2021) Section B1.2.9
13. A floor plan drawing or image indicating location of the <i>storm shelter</i> on a site or within a building or facility; including a drawing or image indicating the entire facility		Submit with safe room plans
14. A <i>storm shelter</i> section or elevation indicating the height of the storm shelter relative to the finished grade, finished floor, and the <i>host building</i> , where applicable.	Ref Detail 3 of applicable Drawing No.	
15. The lowest <i>storm shelter</i> floor elevation and corresponding datum, except for <i>residential tornado shelters</i> outside of <i>special flood hazard areas</i> .		Reference FEMA P-320 Section 3.2 or FEMA P-361 (2021) Section B4.2.3
16. The <i>design occupant capacity</i> (Note: the design occupant capacity for any safe room cannot exceed the usable floor area divided by the minimum usable floor area per safe room occupant)		Reference FEMA P-320 Section 3.4 or FEMA P-361 (2021) Section B5.2.1.2.
17. Calculations for the <i>usable floor area</i> , ft ² (m ²)		Reference FEMA P-320 Section 3.4 or FEMA P-361 (2021) Section B5.2.1.2
18. Calculations for the venting area, in ² (mm ²) provided and locations in the <i>storm shelter</i> .		For residential tornado safe rooms using natural ventilation only, reference ventilation table on Drawing No. SR2.2
19. Calculations for the number of sanitation facilities for <i>community storm shelters</i>	N/A	
20. Minimum foundation capacity requirements including foundation thickness, steel reinforcement, and concrete cover	Ref Details 4 & 5 of applicable Drawing No.	
21. Storm shelter installation requirements, including anchor location, minimum edge and end distance and minimum required capacity for all post-installed anchors.	N/A	
22. For hurricane shelters, the rainfall rate of the roof primary drainage system.		Reference FEMA P-361 (2021) Section B7.2.4
23. For hurricane shelters, the rainfall rate of the roof secondary (overflow) drainage system where required.		Reference FEMA P-361 (2021) Section B7.2.4
24. For hurricane shelters, the rainwater drainage design rainfall rate for facilities subject to rainwater impoundment.		Reference FEMA P-361 (2021) Section B7.2.4

FEMA P-320 (2021) Second Printing of Design Plans	
SHEET TITLE: ICC 500 DESIGN INFORMATION TABLE	
DRAWING NO: SR0.1	Sheet: 2 of 12
DATE: OCTOBER 2021	
Copyright © 2021	

GENERAL NOTES

1. THE DESIGN PLANS REPRESENT THE FINISHED STRUCTURE. THEY DO NOT INCLUDE CONSTRUCTION MEANS AND METHODS. CONTRACTOR SHALL PROVIDE ALL MEASURES NECESSARY TO PROTECT THE STRUCTURE DURING CONSTRUCTION. SUCH MEASURES SHALL INCLUDE BUT ARE NOT LIMITED TO BRACING, SHORING FOR CONSTRUCTION LOADS, TEMPORARY STRUCTURES, AND PARTIALLY COMPLETED WORK.
2. IF THERE IS A CONFLICT AMONG THE GENERAL NOTES, SPECIFICATIONS, AND PLANS, THE MORE STRINGENT CRITERIA SHALL APPLY.
3. THE CONTRACTOR SHALL BE RESPONSIBLE FOR ALL EXCAVATION PROCEDURES INCLUDING SHORING AND PROTECTION OF ADJACENT PROPERTY, STRUCTURES, STREETS, AND UTILITIES IN ACCORDANCE WITH THE LOCAL BUILDING DEPARTMENT. ALL WORK OR CONSTRUCTION SHALL COMPLY WITH ALL APPLICABLE BUILDING CODES, REGULATIONS, AND SAFETY REQUIREMENTS.
4. THE CONTRACTOR SHALL BE RESPONSIBLE FOR VERIFICATION AND COORDINATION OF ALL DIMENSIONS, CONDITIONS AND ELEVATIONS.
5. OPTIONS ARE FOR CONTRACTORS CONVENIENCE. IF AN OPTION IS USED, THE CONTRACTOR SHALL BE RESPONSIBLE FOR ALL NECESSARY CHANGES AND SHALL COORDINATE ALL DETAILS.
6. DETAILS AND NOTES SHALL APPLY, THOUGH NOT NECESSARILY AT A SPECIFIC LOCATION ON PLANS. WHERE NO DETAILS ARE SHOWN, CONSTRUCTION SHALL CONFORM TO SIMILAR WORK ON THE PROJECT. DETAILS MAY ONLY SHOW ONE SIDE OF CONNECTION OR MAY OMIT INFORMATION FOR CLARITY. WHERE DISCREPANCIES OCCUR IN THESE DRAWINGS, NOTES AND DETAILS ON DRAWINGS SHALL TAKE PRECEDENCE OVER GENERAL STRUCTURAL NOTES AND TYPICAL DETAILS.
7. NOT ALL OPENINGS ARE SHOWN IN THESE DRAWINGS. ESTABLISH AND VERIFY ALL OPENINGS AND INSERTS FOR MECHANICAL, PLUMBING, AND ELECTRICAL WITH APPROPRIATE TRADES, DRAWINGS, AND SUBCONTRACTORS PRIOR TO CONSTRUCTION. OPENINGS MAY REQUIRE ADDITIONAL REINFORCING OR SUPPORTS AS SHOWN ON TYPICAL DETAILS. OPENINGS NEED TO BE PROTECTED PER ICC 500-20 SECTION 306.6.
8. COMPLETE INSPECTION REQUIREMENTS SHALL BE AS DIRECTED BY THE LOCAL BUILDING DEPARTMENT.
9. THE DESIGN PLANS SHOULD NOT BE SCALED. DIMENSIONS APPLY.
10. FOLLOW MANUFACTURER'S RECOMMENDATIONS FOR INSTALLING OF UPLIFT/SHEAR RESISTANCE CONNECTORS.
11. TO ENSURE THE SAFE ROOM PROVIDES THE DESIRED LEVEL OF PROTECTION, A PROFESSIONAL ENGINEER OR ARCHITECT SHOULD BE CONSULTED FOR ANY DESIGN CONDITION FOUND TO BE DIFFERENT FROM THOSE REPRESENTED BY THESE PLANS.
12. TO OBTAIN AN EQUIVALENT LEVEL OF PROTECTION, SAFE ROOM DESIGNS NOT MEETING THE SPECIFIC REQUIREMENTS OF THE DESIGNS IN THESE PLANS SHOULD BE DESIGNED TO MEET THE FEMA SAFE ROOM CRITERIA SET FORTH IN THE FEMA P-361 (2021).
13. FOR ALL CONSTRUCTION, USE ONLY SCREWS AND HARDWARE THAT HAVE BEEN EVALUATED THROUGH AN ANSI-APPROVED PRODUCT CERTIFICATION BODY SUCH AS IAPMO-UES OR ICC-ES.
14. VENTILATION IS TO BE PROVIDED PER PLAN DETAILS. VERIFY SIZE REQUIREMENTS BASED ON SAFE ROOM SIZE AND ICC 500-20.
15. MAXIMUM WALL HEIGHT FOR SAFE ROOM SHALL BE 8'-0".
16. REFER TO LOCALLY ADOPTED BUILDING CODE FOR EXTERIOR SAFE ROOM WEATHER PROTECTION REQUIREMENTS.
17. FOR COMMUNITY SAFE ROOMS SEE ICC 500-20 AND FEMA P-361 (2021) FOR ADDITIONAL DESIGN REQUIREMENTS.

SLAB - ON - GROUND GENERAL NOTES:

1. 4" (MINIMUM) SLAB - ON - GROUND REINFORCED WITH WWR 6X6 W2.9XW2.9 (IN SHEETS) OR #4 BARS AT 12" OC EACH WAY. LOCATE REINFORCING IN TOP THIRD OF SLAB. PROVIDE BOLSTERS, CHAIRS, OR OTHER MEANS APPROVED IN WRITING BY THE ENGINEER TO PROPERLY LOCATE REINFORCING.
2. SLAB - ON - GROUND INSIDE THE BUILDING STRUCTURE SHALL BE SUPPORTED ON A 6" DRAINAGE COURSE. DRAINAGE COURSE SHALL BE AS FOLLOWS: COURSE OF CLEAN WASHED GRANULAR MATERIAL PLACED TO CUT OFF UPWARD CAPILLARY FLOW OF GROUND WATER, OR TO PROVIDE A STABLE BASE FOR PIPES OR OTHER STRUCTURES. MATERIAL SHALL BE WASHED, EVENLY GRADED MIXTURE OF CLEAN CRUSHED STONE, OR CRUSHED OR UNCRUSHED GRAVEL, ASTM D 448, COARSE AGGREGATE GRADING SIZE 57, WITH 100 PERCENT PASSING A 1-1/2 INCH SIEVE AND NOT MORE THAN 5 PERCENT PASSING A NO. 8 SIEVE.
3. CONSULT WITH LOCAL CODE OFFICIAL FOR VAPOR RETARDER RECOMMENDATIONS.
4. PROVIDE JOINT FILLER AT THE INTERFACE OF ALL WALL AND SLAB JOINTS.
5. ALL EXPANSIVE CLAYS WITHIN 24" OF FLOOR SLABS SHALL BE REMOVED. ALL FILL BELOW FLOOR SLABS SHALL BE PROPERLY COMPACTED AND SUBGRADE BROUGHT TO A TRUE AND LEVEL PLANE BEFORE PLACEMENT OF ANY CONCRETE.

CONCRETE NOTES

1. REINFORCING BAR DETAILING, FABRICATING, AND PLACING SHALL CONFORM TO THE "ACI STANDARD: DETAILS AND DETAILING OF CONCRETE REINFORCEMENT" (ACI 315) AND THE "MANUAL OF ENGINEERING AND PLACING DRAWINGS FOR REINFORCED CONCRETE STRUCTURES" (ACI 315R) BY THE AMERICAN CONCRETE INSTITUTE. THE MOST CURRENT EDITIONS OF CONCRETE REINFORCING STEEL INSTITUTE'S "REINFORCING BAR DETAILING" AND "PLACING REINFORCING BARS" MAY ALSO BE USED.
2. REINFORCING STEEL SHALL CONFORM TO THE REQUIREMENTS OF ASTM A615. REINFORCING SHALL BE GRADE 60 (FY=60 KSI) DEFORMED BARS FOR ALL BARS UNLESS NOTED OTHERWISE ON PLANS OR DETAILS. ALL REINFORCING TO BE WELDED SHALL BE ASTM A706, GRADE 60 LOW ALLOY WELDABLE STEEL.
3. WELDING OF REINFORCING BARS, METAL INSERTS, AND CONNECTIONS SHALL CONFORM TO AMERICAN WELDING SOCIETY'S AWS D1.4 – STRUCTURAL WELDING CODE, AND SHALL BE MADE ONLY AT LOCATIONS SHOWN ON PLANS OR DETAILS.
4. ALL REINFORCING SHALL BE BENT COLD. BARS SHALL NOT BE STRAIGHTENED AND RE-BENT. FIELD BENDING OF REBAR SHALL NOT BE ALLOWED UNLESS SPECIFICALLY NOTED OTHERWISE.
5. REINFORCING BAR SPACING SHOWN ON PLANS IS AT MAXIMUM ON CENTERS. ALL BARS SHALL BE DETAILED AND PLACED WITHIN 1/2" TOLERANCE IN ANY DIRECTION. SECURELY TIE ALL BARS IN LOCATION BEFORE PLACING CONCRETE.
6. REINFORCING BAR CLEAR COVER REQUIREMENTS:
 - a. CONCRETE PLACED AGAINST EARTH – 3"
 - b. CONCRETE PLACED IN FORMS – 1.5"
7. WELDED WIRE REINFORCING SHALL CONFORM TO THE REQUIREMENTS OF ASTM A1064. LAPS IN WELDED WIRE REINFORCING SHALL BE MADE SUCH THAT THE OVERLAP, MEASURED BETWEEN OUTERMOST CROSS WIRE OF EACH SHEET, IS NOT LESS THAN THE SPACING OF CROSS WIRES PLUS 2 INCHES.
8. MECHANICAL SPLICE COUPLERS, FLANGE COUPLERS, THREADED COUPLERS, ETC. SHALL HAVE CURRENT ANSI-APPROVED PRODUCT CERTIFICATION BODY SUCH AS IAPMO-UES OR ICC-ES APPROVAL AND SHALL BE CAPABLE OF DEVELOPING 125% OF THE STRENGTH OF THE BAR.
9. PROVIDE BAR SUPPORTS: BOLSTERS, CHAIRS, SPACERS, AND OTHER DEVICES FOR SPACING, SUPPORTING, AND FASTENING REINFORCING BARS AND WELDED WIRE REINFORCEMENT IN PLACE. MANUFACTURE BAR SUPPORTS FROM STEEL WIRE, PLASTIC, OR PRECAST CONCRETE ACCORDING TO CRSI'S "MANUAL OF STANDARD PRACTICE."
10. PROVIDE TEMPORARY SHORING AND BRACING OF ALL STRUCTURAL AND MISCELLANEOUS ELEMENTS UNTIL CONCRETE HAS OBTAINED 80% OF DESIGN STRENGTH.
11. WHEN PLACING CONCRETE IN HOT WEATHER, REFER TO ACI 305R AND ACI 305.1. WHEN PLACING CONCRETE IN COLD WEATHER, REFER TO ACI 306R AND ACI 306.1.
12. ALL BELOW GRADE CONSTRUCTION JOINTS SHALL HAVE A CONTINUOUS WATERSTOP CAST INTEGRALLY INTO THE JOINT.
13. WHERE FOOTINGS, WALLS, OR OTHER STRUCTURAL ELEMENTS INTERSECT, CORNER, OR TEE, PROVIDE CORNER BARS WITH REQUIRED LAP LENGTHS TO PROVIDE CONTINUITY OF HORIZONTAL STEEL REINFORCING UNO.
14. PROVIDE MINIMUM 3" COVER FOR ANCHOR BOLTS AND LOCATE HORIZONTAL REINFORCEMENT TO THE OUTSIDE FOR ANCHOR BOLT CONTAINMENT UNO.
15. FOLLOW ALL MANUFACTURER'S INSTALLATION RECOMMENDATIONS WHERE DOWELS, BOLTS, OR INSERTS ARE CALLED TO BE ANCHORED TO CAST IN PLACE CONCRETE ELEMENTS USING EPOXY ADHESIVES OR MECHANICAL ANCHORAGE.
16. FLY ASH MAY BE USED AS A ONE TO ONE REPLACEMENT UP TO 20% FOR THE TOTAL CEMENTITIOUS MATERIAL CONTENT AS LONG AS THE AMBIENT TEMPERATURE IS ABOVE 50 DEGREES FAHRENHEIT. FLY ASH SHALL BE CLASS C CONFORMING TO ASTM C 618.
17. ALL CONCRETE EXPOSED TO FREEZING SHALL BE AIR ENTRAINED. AIR CONTENT OF FRESH CONCRETE SHALL BE 5-7%.
18. NO LIME SAND FINE AGGREGATE MAY BE USED IN CONCRETE EXPOSED TO WEATHER, VIEW, OR IN HORIZONTAL APPLICATIONS.
19. DO NOT USE AIR ENTRAINED CONCRETE FOR FLOORS WITH A TROWELED FINISH. AT SUCH LOCATIONS ENTRAPPED AIR CONTENT SHALL NOT EXCEED 3%.
20. CONCRETE FOR FOUNDATION WALLS, FOOTINGS, AND INTERIOR SLABS ON GRADE SHALL HAVE A 28-DAY COMPRESSIVE STRENGTH OF 3,000 PSI WITH A SLUMP OF 4" ± 1". THE MAXIMUM WATER TO CEMENTITIOUS MATERIALS RATIO SHALL BE 0.45 BY WEIGHT.
21. CONCRETE FOR CAST-IN-PLACE WALL SHALL HAVE A 28-DAY COMPRESSIVE STRENGTH OF 4,000 PSI WITH A SLUMP OF 4" ± 1". THE MAXIMUM WATER TO CEMENTITIOUS MATERIALS RATIO SHALL BE 0.45 BY WEIGHT.
22. IF ADDITIONAL FLOWABILITY IS REQUIRED FOR PLACEMENT OF ANY CONCRETE MIX, A WATER-REDUCING ADDITIVE CONFORMING TO ASTM C494, TYPE A, D, E, OR F SHALL BE USED. NO ADDITIONAL WATER MAY BE ADDED TO THE MIX AT THE SITE. SLUMP FOR CONCRETE CONTAINING WATER-REDUCING OR HIGH-RANGE WATER-REDUCING ADMIXTURE SHALL NOT EXCEED 8" AFTER ADMIXTURE IS INCORPORATED INTO CONCRETE WITH A 2"-4" SLUMP.

COLD-FORM (LIGHT GAUGE) SHEATHING NOTES

1. YIELD STRENGTH FOR METAL IS 36 KSI MINIMUM
2. IN HURRICANE-PRONE REGIONS, ALL METAL SHOULD BE G60 GALVANIZED BY THE MANUFACTURER.
3. SAFE ROOM W/ STEEL SHEATHING COVERED W/ GYP. BOARD FINISH OR OTHERWISE SEPARATED FROM CONTACT BY SAFE ROOM OCCUPANTS NEED NOT BE GROUNDED.
4. SAFE ROOM W/ STEEL SHEATHING UNCOVERED AND AVAILABLE FOR CONTACT BY SAFE ROOM OCCUPANTS MUST BE GROUNDED AT A SINGLE LOCATION W/ COPPER WIRE AND GROUND ROD TO MEET NATIONAL ELECTRIC CODE AND LOCAL REQUIREMENTS.

DOOR NOTES

1. THE SELECTED DOOR SHALL MEET THE DESIGN CRITERIA OF FEMA P-361 (2021) AND ICC-500-20. ALL DOORS SHALL BE A TESTED, LISTED, AND LABELED ASSEMBLY AND INSTALLED PER MANUFACTURERS RECOMMENDATIONS.
2. FOR WOOD FRAMED SAFE ROOM, DOOR MUST BE PLACED ON LONGEST WALL.
3. FOR WOOD FRAMED SAFE ROOM, INSTALL ROOF JOISTS TO BEAR ON WALL WITHOUT DOOR OPENING.

ABBREVIATION LEGEND

AB	ANCHOR BOLT
ACI	AMERICAN CONCRETE INSTITUTE
AISC	AMERICAN INSTITUTE OF STEEL CONSTRUCTION
AISI	AMERICAN IRON AND STEEL INSTITUTE
ALT	ALTERNATE
AWS	AMERICAN WELDING SOCIETY
BO	BOTTOM OF
BRG	BEARING
BTM	BOTTOM
CIP	CAST IN PLACE CONCRETE WALL
CMU	CONCRETE MASONRY UNIT
CONC	CONCRETE
CONN	CONNECTION
CONT	CONTINUOUS
DIA	DIAMETER
DBL	DOUBLE
EL	ELEVATION
EQ	EQUAL
EW	EACH WAY
FND	FOUNDATION
FF	FINISHED FLOOR
FTG	FOOTING
GA	GAGE
GYP	GYPSUM
HORIZ	HORIZONTAL
ICF	INSULATED CONCRETE FORMS
INFO	INFORMATION
KSI	KIPS PER SQUARE INCH
L	LENGTH
LB	POUNDS
LONG	LONGITUDINAL
MAX	MAXIMUM
MEP	MECHANICAL, ELECTRICAL, PLUMBING
MFR	MANUFACTURER
MIN	MINIMUM
MISC	MISCELLANEOUS
ML	MASONRY LINTEL
MTL	METAL
NS/FS	NEAR SIDE/FAR SIDE
NTS	NOT TO SCALE
OC	ON CENTER
PCF	POUNDS PER CUBIC FOOT
PLF	POUNDS PER LINEAR FOOT
PSF	POUNDS PER SQUARE FOOT
PSI	POUNDS PER SQUARE INCH
PT	PRESSURE TREATED
RE	REFER TO
REINF	REINFORCING
SIM	SIMILAR
SF	SQUARE FOOT
SFRM	SAFE ROOM
SOG	SLAB - ON - GROUND
SPEC	SPECIFICATIONS
T	THICKNESS
T&B	TOP AND BOTTOM
TO	TOP OF
TOC	TOP OF CONCRETE ELEVATION
TOF	TOP OF FOOTING ELEVATION
TOW	TOP OF WALL ELEVATION
TYP	TYPICAL
UNO	UNLESS NOTED OTHERWISE
W	WIDTH
W/	WITH
WWR	WELDED WIRE REINFORCING

FEMA P-320 (2021)

Second Printing of Design Plans

SHEET TITLE:

GENERAL NOTES

DRAWING NO: **SR0.2**

Sheet: 3 of 12

DATE: OCTOBER 2021

Copyright © 2021

DESIGN CRITERIA	FEMA P-320 (2021)
1. DESIGN CRITERIA	
A. THE DESIGNS HEREIN CONFORM TO THE PROVISIONS OF THE ICC 500-20 AND FEMA P-361 (2021)	
2. DESIGN CODES	FEMA P-361 (2021) ICC 500-20
3. GRAVITY LOADS	
A. TYPICAL ROOF DEAD LOAD COLLATERAL LOAD	SELF WEIGHT 5 PSF
B. LIVE LOADS TYPICAL ROOF LIVE LOAD (LR)	100 PSF MIN
C. ROOF SNOW LOAD	
- CONSULT LOCAL PROFESSIONAL ENGINEER FOR THE DESIGN OF SNOW LOADS WHEN SNOW LOADS COULD EXCEED THE SPECIFIED ROOF LIVE LOAD.	
4. LATERAL LOADS	
A. WIND LOADS	
WIND SPEED	250 MPH
WIND IMPORTANCE FACTOR (I)	1.0
EXPOSURE CATEGORY	C
DIRECTIONALITY FACTOR (Kd)	1.0
TOPOGRAPHIC FACTOR (Kzt)	1.0
GROUND ELEVATION FACTOR (Ke)	1.0
INTERNAL PRESSURE (GCpi)	±0.55
B. SEISMIC LOADS	
- IN AREAS OF HIGH OR MODERATE SEISMIC DESIGN, CONSULT A LOCAL DESIGN PROFESSIONAL. SEE SECTION 5.2.2 OF P-320 FOR MORE INFORMATION.	
5. MISSILE IMPACT CRITERIA	
· VERTICAL SURFACES	15 POUND 2x4 AT 100MPH
· HORIZONTAL SURFACES	15 POUND 2x4 AT 67MPH

FOUNDATION NOTES

- ALL FOOTINGS SHALL BEAR ON AND BE FORMED BY CLEAN, UNDISTURBED, VIRGIN, NON-ORGANIC SOIL OR CONTROLLED ENGINEERED FILL WITH A MINIMUM NET BEARING CAPACITY OF 1500 PSF.
- EXTERIOR FOOTINGS SHALL BEAR AT OR BELOW MINIMUM BEARING DEPTH PER THE LOCAL BUILDING OFFICIAL EXCEPT FOR WOOD FRAMED OPTION WHERE MINIMUM BEARING DEPTH IS 30" BELOW ADJACENT FINISHED GRADE.
- STANDARD PROCEDURES OF FROST PROTECTION FOR FOUNDATIONS AND EXCAVATIONS SHALL BE EMPLOYED FOR WINTER CONSTRUCTION. BACKFILLING OF EXCAVATIONS SHALL BE DONE AS SOON AS POSSIBLE TO PROTECT FOUNDATIONS FROM FROST.
- ALL SOIL BELOW SLABS AND FOOTINGS SHALL BE PROPERLY COMPACTED AND SUBGRADE BROUGHT TO A TRUE AND LEVEL PLANE BEFORE PLACING CONCRETE.
- FOUNDATION WALLS SHALL HAVE TEMPORARY BRACING BEFORE BACKFILL IS PLACED AGAINST THEM. TEMPORARY BRACING SHALL NOT BE REMOVED UNTIL WALL IS PERMANENTLY BRACED.
- FOUNDATION PENETRATIONS SHALL BE SUBJECT TO APPROVAL BY A PROFESSIONAL ENGINEER OR ARCHITECT. PENETRATIONS SHALL BE THROUGH THE FOUNDATION STEMWALL OR WITH A MINIMUM OF 6" COVER BELOW FOOTING.
- IN AREA OF THE BUILDING, EXISTING ORGANIC MATERIAL, UNSUITABLE SOIL, ABANDONED FOOTINGS, AND ANY OTHER EXISTING UNSUITABLE MATERIALS SHALL BE REMOVED.
- DRAINAGE FILL SHALL BE A FREE-DRAINING GRANULAR MATERIAL. USE #57 STONE OR APPROVED EQUAL. REFER TO ASTM D448 FOR GRADATION.
- EXCAVATION FOR FOOTINGS SHALL BE CUT TO ACCURATE SIZE AND DIMENSIONS AS SHOWN ON PLANS. ALL LOOSE MATERIAL BELOW FOOTINGS SHALL BE REMOVED AND THE SURFACE BROUGHT TO A REASONABLE TRUE AND LEVEL PLANE BEFORE PLACING CONCRETE.
- WHEN INSTALLATION AND FOUNDATION REQUIREMENTS ARE ADDRESSED BY A LOCAL DESIGN PROFESSIONAL, THESE DESIGNS SHALL EXCEED THE DESIGN REQUIREMENTS SET FORTH IN THE ICC 500-20 FOR RESIDENTIAL SHELTERS FOR BOTH TORNADO AND HURRICANE HAZARDS.

MASONRY GENERAL NOTES

- COMPRESSIVE STRENGTH OF CONCRETE MASONRY CONSTRUCTION (CMU) SHALL BE AS FOLLOWS: MASONRY STRENGTH NOT SPECIFICALLY NOTED IN PLAN SHALL BE $f'_{m} = 1,500$ PSI MINIMUM.
- CONCRETE MASONRY SHALL BE HOLLOW LOAD-BEARING CONCRETE MASONRY UNITS CONFORMING TO ASTM C90. ALL UNITS SHALL BE PLACED IN RUNNING BOND CONSTRUCTION WITH ALL VERTICAL CELLS IN ALIGNMENT.
- MORTAR SHALL CONFORM TO REQUIREMENTS OF TYPE M OR S.
- REINFORCING STEEL SHALL CONFORM TO THE REQUIREMENTS OF ASTM A615. REINFORCING SHALL BE GRADE 60 (FY=60 KSI) DEFORMED BARS FOR ALL BARS UNLESS NOTED OTHERWISE ON PLANS OR DETAILS. ALL REINFORCING TO BE WELDED SHALL BE ASTM A706, GRADE 60 LOW ALLOY WELDABLE STEEL.
- WELDING OF REINFORCING BARS, METAL INSERTS, AND CONNECTIONS SHALL CONFORM TO AMERICAN WELDING SOCIETY'S AWS D1.4 – STRUCTURAL WELDING CODE, AND SHALL BE MADE ONLY AT LOCATIONS SHOWN ON PLANS OR DETAILS.
- ALL REINFORCING SHALL BE BENT COLD. BARS SHALL NOT BE STRAIGHTENED AND RE-BENT. FIELD BENDING OF REBAR SHALL NOT BE ALLOWED UNLESS SPECIFICALLY NOTED OTHERWISE.
- REINFORCING BAR SPACING SHOWN ON PLANS ARE AT MAXIMUM ON CENTERS. ALL BARS SHALL BE DETAILED AND PLACED WITHIN 1/2" TOLERANCE PERPENDICULAR TO THE WALL AND WITHIN 2" TOLERANCE PARALLEL TO THE WALL. SUPPORT ALL REINFORCEMENT TO PREVENT DISPLACEMENT CAUSED BY CONSTRUCTION LOADS OR BY PLACEMENT OF GROUT AND MORTAR BEYOND ALLOWABLE TOLERANCES.
- MASONRY GROUT SHALL BE IN ACCORDANCE WITH ASTM C476. GROUT EXCEPT FOR SELF-CONSOLIDATING GROUT SHALL HAVE A SLUMP BETWEEN 8 AND 11" WHEN MEASURED IN ACCORDANCE WITH ASTM C143. ALL CELLS IN CONCRETE MASONRY UNITS SHALL BE SOLID GROUTED.
- REFERENCE MASONRY DEVELOPMENT AND SPLICE TABLE FOR REINFORCING BAR LAP LENGTHS IN MASONRY CONSTRUCTION.
- MINIMUM VERTICAL WALL REINFORCING SHALL BE AS INDICATED IN THE PLANS AND SHALL BE FULL HEIGHT IN CENTER OF GROUTED CELL AT WALL INTERSECTIONS, CORNERS AND DOOR JAMBS.
- MINIMUM HORIZONTAL WALL REINFORCING SHALL INCLUDE A BOND BEAM AT THE TOP OF THE WALL WITH 1 NO. 4 BAR CONTINUOUS AROUND THE PERIMETER AND 9 GA. GALV LADDER TYPE JOINT REINFORCING SPACED AT 16" OC ABOVE GRADE AND 8" OC BELOW GRADE OR BOND BEAMS AT 48" OC WITH 1 NO. 4 BAR CONTINUOUS.
- MINIMUM MASONRY LINTEL SHALL BE AS INDICATED IN THE PLANS. ALL LINTEL REINFORCING SHALL EXTEND 2 FEET PAST JAMBS UNLESS NOTED OTHERWISE ON PLANS OR DETAILS.
- LOOSE ANGLE BRICK LINTELS SHALL BE SPECIFIED BY OTHERS.
- RETAINING WALLS, BASEMENT WALLS, ETC., SHALL BE ADEQUATELY WATERPROOFED AND DRAINED AS SPECIFIED BY OTHERS.
- WHERE VERTICAL REINFORCING INTERSECTS HORIZONTAL REINFORCING, BOTH SHALL BE CONTINUOUS.
- MAXIMUM HEIGHT FOR GROUT POUR SHALL NOT EXCEED 64" UNLESS A CLEANOUT IS PROVIDED AT THE BOTTOM OF EACH CELL CONTAINING REINFORCEMENT OR AT A MAXIMUM HORIZONTAL SPACING OF 32" WHICHEVER IS LESS.
- FOLLOW ALL MANUFACTURER'S INSTALLATION RECOMMENDATIONS WHERE DOWELS, BOLTS, OR INSERTS ARE CALLED TO BE ANCHORED TO CAST IN PLACE CONCRETE ELEMENTS USING EPOXY ADHESIVES OR MECHANICAL ANCHORAGE.

INSULATED CONCRETE FORMS GENERAL NOTES

- ICF SYSTEM UTILIZED SHALL BE FLAT PANEL SYSTEM PROVIDING CONSISTENT WALL THICKNESS ACROSS THE ENTIRE WALL. DO NOT USE WAFFLE, SCREEN, POST AND BEAM, ETC. ICF SYSTEMS.
- EXTREME CARE SHOULD BE TAKEN WHEN VIBRATING THE CONCRETE INSIDE THE PERMANENT ICF FORMS TO ASSURE CONSOLIDATION OF CONCRETE AND TO ELIMINATE VOIDS IN THE WALL. LIKewise, CARE SHOULD BE TAKEN NOT TO OVER-VIBRATE CONCRETE THUS SEGREGATING AGGREGATE.
- REFERENCE ICF MANUFACTURER FOR MAXIMUM POUR HEIGHTS.
- CONCRETE FOR ICF WALLS SHALL HAVE A 28-DAY COMPRESSIVE STRENGTH OF 4,000 PSI WITH A SLUMP OF 6"±1" PER MANUFACTURER RECOMMENDATIONS. THE MAXIMUM WATER TO CEMENTITIOUS MATERIALS RATIO SHALL BE 0.45 BY WEIGHT.

GENERAL WOOD FRAMING NOTES

- ALL LUMBER SHALL BE IDENTIFIED BY A GRADEMARK OF THE GRADING AGENCY WHICH COMPLIES WITH THE REQUIREMENTS OF U.S. DEPT. OF COMMERCE VOLUNTARY PRODUCT STANDARD PS20. WOOD FRAMING LUMBER TO HAVE MODULUS OF ELASTICITY = 1,200,000 PSI MIN. AND $F_b = 850$ PSI. MIN. FOR NORMAL DURATION LOADING. EXAMPLES OF ACCEPTABLE GRADE AND SPECIES OF FRAMING LUMBER INCLUDE #2 AND BETTER SOUTHERN PINE, DOUGLAS FIR, HEM-FIR, AND SPRUCE-PINE-FIR.
- PLYWOOD SHALL MEET THE PROVISIONS OF U.S. DEPT OF COMMERCE VOLUNTARY PRODUCT STANDARD PS1 AND PS2, AND SHALL BE IDENTIFIED FOR GRADE, BOND CLASSIFICATION, AND PERFORMANCE CATEGORY BY THE TRADEMARKS OF AN APPROVED TESTING AND GRADING AGENCY. PLYWOOD SHOULD BE RATED SHEATHING SPAN RATING 32/16, MIN. 23/32 THICKNESS.
- NAILS SHALL BE COMMON WIRE NAILS AS SPECIFIED ON THE PLANS.
- FOLLOW MANUFACTURER'S RECOMMENDATIONS FOR INSTALLATION OF UPLIFT/SHEAR RESISTANCE CONNECTORS.
- ALL PLYWOOD JOINTS SHOULD BE SOLIDLY BLOCKED w/ DIMENSIONAL LUMBER OF MATCHING DEPTH.
- WALL AND CEILING PENETRATIONS THROUGH THE MISSILE PROTECTION SHEATHING SHALL BE MINIMIZED.
- DO NOT DRILL THROUGH WALL STUDS OR TOP AND BOTTOM PLATES FOR MEP SUPPLY LINES OR VENTS. INSTALL MEP SUPPLY LINES AND VENTS IN PLUMBING CHASE.
- WHERE CALLED FOR ON THE PLANS TO USE FRAMING ANCHORS USE GALVANIZED (G90) OR CORROSION-RESISTANT EQUIVALENT STEEL FRAMING ANCHORS.
- ALL LUMBER IN CONTACT WITH CONCRETE OR MASONRY SHALL BE TREATED AND SHALL COMPLY WITH APPLICABLE REQUIREMENTS OF AWPA STANDARD U1, USE CATEGORY UC3B.
- AT OPENINGS PROVIDE FOUR (4) 2X TRIMMER STUDS AT EACH SIDE OF OPENING.
- INSTALL REQUIRED SHEATHING ON OUTSIDE FACE OF WALL OR ROOF ONLY AS PER DETAILS ON SR2.1.

FEMA P-320 (2021) Second Printing of Design Plans	
SHEET TITLE: GENERAL NOTES	
DRAWING NO: SR0.3	Sheet: 4 of 12
DATE: OCTOBER 2021	
Copyright © 2021	

HOOKED DOWEL DEVELOPMENT LENGTHS IN TENSION (INCHES)

BAR SIZE	EMBEDMENT	EXTENSION	
	3000 PSI CONCRETE	90° HOOK	MINIMUM DIA OF BEND "D" (IN)
#4	8	6.0	3.00
#5	10	7.5	3.75

NOTES:
1. DEVELOPMENT LENGTH IS BASED ON 2 1/2" MINIMUM SIDE COVER AND 2" MINIMUM END COVER

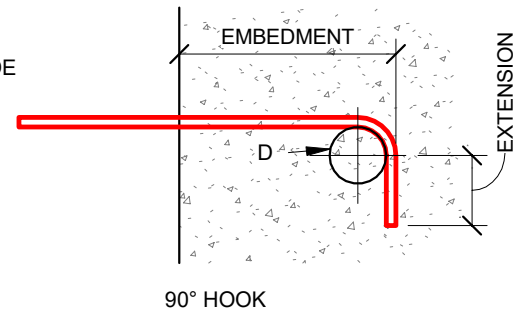

7 HOOKED BAR TABLE

SR0.4

CONCRETE DEVELOPMENT AND SPLICE

LAP SPLICE LENGTHS (INCHES)

BAR SIZE	TENSION (CLASS B SPLICE)						COMPRESSION
	f'c=3000 psi		f'c=4000 psi		f'c=5000 psi		3000, 4000 & 5000 psi
	TOP	OTHER	TOP	OTHER	TOP	OTHER	
4	23	17	21	16	21	16	15
5	28	21	24	18	23	17	19

DEVELOPMENT LENGTHS (INCHES)

BAR SIZE	TENSION (CLASS B SPLICE)						COMPRESSION
	f'c=3000 psi		f'c=4000 psi		f'c=5000 psi		3000, 4000 & 5000 psi
	TOP	OTHER	TOP	OTHER	TOP	OTHER	
4	33	22	29	19	26	17	11
5	42	28	36	24	32	22	14

NOTES:
1. LAP SPLICE LENGTHS ARE BASED ON BARS SPACED AT 4 BAR DIAMETERS OR MORE ON CENTER. NOTIFY ENGINEER IF SPACING IS LESS THAN 4 BAR DIAMETERS.

5 CONCRETE DEVELOPMENT AND SPLICE TABLE

SR0.4

MASONRY DEVELOPMENT AND SPLICE LENGTHS

BAR SIZE	TENSION / COMPRESSION
	8" MASONRY
4	15
5	23

6 MASONRY DEVELOPMENT & SPLICE LENGTHS

SR0.4

ROOF DESIGN OPTIONS

MATERIAL	SPAN	8 FT	≤ 10 FT	≤ 12 FT	≤ 14 FT
	CONCRETE	CONCRETE THICKNESS	4"	6"	6"
REINFORCEMENT		#4 BAR EW AT 10" OC	#5 BAR EW AT 12" OC	#5 BAR EW AT 6" OC	#5 BAR EW AT 6" OC
WOOD	JOIST(S)	(2) 2x6 AT 12" OC	(2) 2x8 AT 12" OC	(2) 2x10 AT 12" OC	(2) 2x10 AT 12" OC

NOTES:
1. WOOD FRAMED SAFE ROOMS CAN ONLY USE WOOD FRAMED ROOF DESIGNS
2. FOR WOOD FRAMED SAFE ROOM, INSTALL ROOF JOISTS TO BEAR ON WALL WITHOUT DOOR OPENING.

3 ROOF DESIGN OPTIONS

SR0.4

WALL REINFORCEMENT SCHEDULE

WALL TYPE	WALL REINFORCEMENT		OPENING REINFORCEMENT		NOTES
	VERTICAL	HORIZONTAL	VERTICAL (JAMB)	HORIZONTAL (LINTEL)	
8" CMU	(1) #5 BAR AT 32" OC	LADDER REINFORCING AT 16" OC OR BOND BEAM @ 48" OC	(1) #5 BAR PER CELL OVER 2'-0"	8" LINTEL w/ (1) #5 BAR	2, 3, 4
6" CONCRETE	#4 BAR AT 12" OC	#4 BAR AT 12" OC	(3) #5 BAR AT 6" OC	(1) #5 BAR TOP AND BTM	2, 3, 4
8" CONCRETE	#4 BAR AT 12" OC	#4 BAR AT 12" OC	(3) #5 BAR AT 6" OC	(1) #5 BAR TOP AND BTM	2, 3, 4
6" ICF	#4 BAR AT 12" OC	#4 BAR AT 12" OC	(3) #5 BAR AT 6" OC	(1) #5 BAR TOP AND BTM	1, 2, 3, 4

NOTES:
1. ICF WALL THICKNESS REFERS TO THE CONCRETE THICKNESS OF THE ICF WALL, NOT THE TOTAL THICKNESS OF THE WALL.
2. ALL LINTEL REINFORCING SHALL EXTEND 2 FEET PAST JAMBS.
3. REFERENCE CONCRETE NOTES AND MASONRY GENERAL NOTES FOR ADDITIONAL REINFORCEMENT SPECIFICATIONS.
4. WHERE DISTANCE BETWEEN DOOR OPENING AND OUTER WALL CORNER IS LESS THAN 2', EXTEND LINTEL REINFORCEMENT AROUND WALL CORNER & SET THIRD VERTICAL BAR IN ADJACENT WALL.

1 WALL REINFORCEMENT SCHEDULE

SR0.4

WOOD CONSTRUCTION CONNECTOR SCHEDULE

CONNECTOR TYPE	SIMPSON STRONG-TIE	MiTek	NOTES
A	(2) GA1	(2) A3	INSTALL (1) ON EA SIDE OF MEMBER @ EA LOCATION (TYP.) AND ON INSIDE FACE ONLY @ END JOISTS
B	THDB62800H w/BPS 5/8-6	SACH58800-EXT w/HBPS58-412	MINIMUM 8" LONG ANCHOR SCREW, SEE NOTE #1
C	HU26-2 (MAX.)	HD26-2 (MAX.)	@ 2x6 JOISTS, INSTALL HANGER UPSIDE DOWN
	HU28-2 (MAX.)	HD28-2 (MAX.)	@ 2x8 JOISTS, INSTALL HANGER UPSIDE DOWN
	HU210-2 (MAX.)	HD210-2 (MAX.)	@ 2x10 JOISTS, INSTALL HANGER UPSIDE DOWN
D	(2) HETA16	(2) HTA16	SEE NOTE #2
E	HGAM10KTA	HGAM10KT	
F	LGT2	LUGT2	SEE NOTE #3, #4
G	(2) TSP	(2) TSP	INSTALL (1) ON EA SIDE OF MEMBER @ EA LOCATION
H	PA18	PA18	OMIT NAILS IN CONNECTOR "H" WHERE IT OVERLAPS CONNECTOR "C"
J	HDU4 w/THDB62800H	PHD4A w/SACH58800-EXT	SEE NOTE #5

NOTES:
1. CENTER THE PLATE WASHER ON THE BOTTOM PLATE WITH A STANDARD CUT WASHER BETWEEN THE PLATE WASHER AND NUT. WHEN IN CONTACT WITH PRESERVATIVE TREATED PLATE, IT IS RECOMMENDED TO INSTALL HOT-DIPPED GALVANIZED (HDG) FINISH.
2. INSTALL (1) ON EA SIDE OF JOIST, STAGGERED, AND A MINIMUM OF 1 1/2" FROM END OF JOIST.
3. INSTALL ALL "F" CONNECTORS ON INSIDE FACE OF WALL.
4. AT CORNERS, ATTACH JOIST TO STUD WITH HTS 16 (SST) OR HTW16 (MiTek) IN LIEU OF LGT2 OR LUGT2.
5. WHERE DISTANCE FROM OUTER CORNER OF FRAMED WALL AND DOOR OPENING IS 16" OR GREATER, INSTALL CONNECTOR J AT BOTH DOOR OPENING SUPPORTS AND EACH WALL CORNER. WHERE LESS THAN 16", INSTALL STUDS AS SHOWN IN DETAIL 1/SR1.3 WITH CONNECTORS J AT OPPOSITE DOOR OPENING SUPPORT ONLY AND EACH WALL CORNER.

BECAUSE NOT ALL CONTRACTORS ARE FAMILIAR WITH THE TYPE OF STRUCTURAL CONNECTORS SHOWN IN THESE DRAWINGS, THE NAMES OF TWO COMPANIES THAT MANUFACTURE CONNECTORS HAVE BEEN INCLUDED IN THIS TABLE. THE LIST OF COMPANIES IS NOT, HOWEVER, EXHAUSTIVE. ADDITIONALLY, THIS LIST IS NOT INTENDED TO EXPRESS A PREFERENCE FOR THOSE MANUFACTURERS AND / OR THEIR PRODUCTS BY THE UNITED STATES GOVERNMENT NOR IS IT AN ENDORSEMENT OF THOSE MANUFACTURERS AND / OR THEIR PRODUCTS.

USE ONLY HARDWARE THAT HAS BEEN EVALUATED THROUGH AN ANSI-APPROVED PRODUCT CERTIFICATION BODY SUCH AS IAPMO-UES OR ICC-ES.

4 WOOD CONSTRUCTION CONNECTOR SCHEDULE

SR0.4

FOOTING SCHEDULE

WALL TYPE	ROOF TYPE	FOOTING SIZE	REINFORCEMENT
WOOD FRAME	WOOD	4'-0" x 1'-6" x CONT	(5) #5 BAR x CONT LONG. AND #5 BAR x 3'-6" TRANS AT 12" OC
8" CMU	WOOD OR CONCRETE	2'-0" x 1'-0" x CONT	(3) #5 BAR x CONT LONG. AND #5 BAR x 1'-6" TRANS AT 12" OC
CONCRETE	WOOD	2'-3" x 1'-3" x CONT	(4) #5 BAR x CONT LONG. AND #5 BAR x 1'-9" TRANS AT 12" OC
	CONCRETE	2'-0" x 1'-0" x CONT	(3) #5 BAR x CONT LONG. AND #5 BAR x 1'-6" TRANS AT 12" OC
ICF	WOOD	2'-3" x 1'-3" x CONT	(4) #5 BAR x CONT LONG. AND #5 BAR x 1'-9" TRANS AT 12" OC
	CONCRETE	2'-0" x 1'-0" x CONT	(3) #5 BAR x CONT LONG. AND #5 BAR x 1'-6" TRANS AT 12" OC

2 FOOTING SCHEDULE

SR0.4

FEMA P-320 (2021)
Second Printing of Design Plans

SHEET TITLE: **TABLES**

DRAWING NO: **SR0.4** Sheet: 5 of 12

DATE: OCTOBER 2021

Copyright © 2021

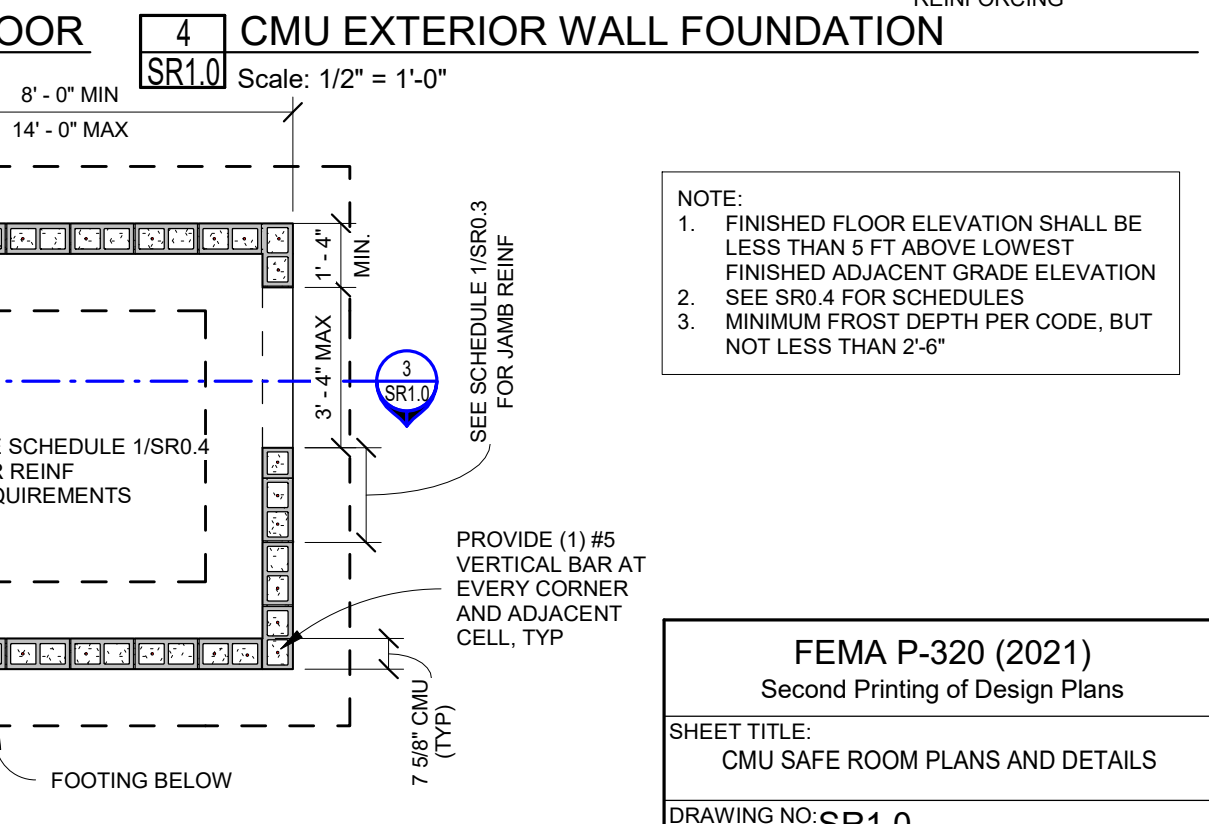
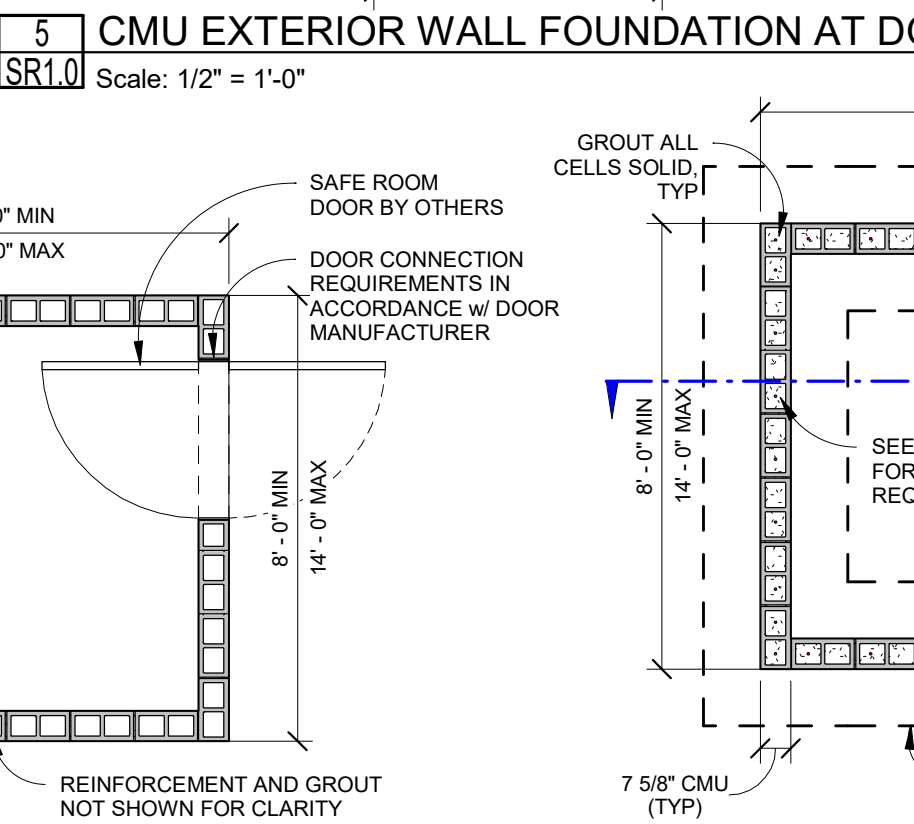
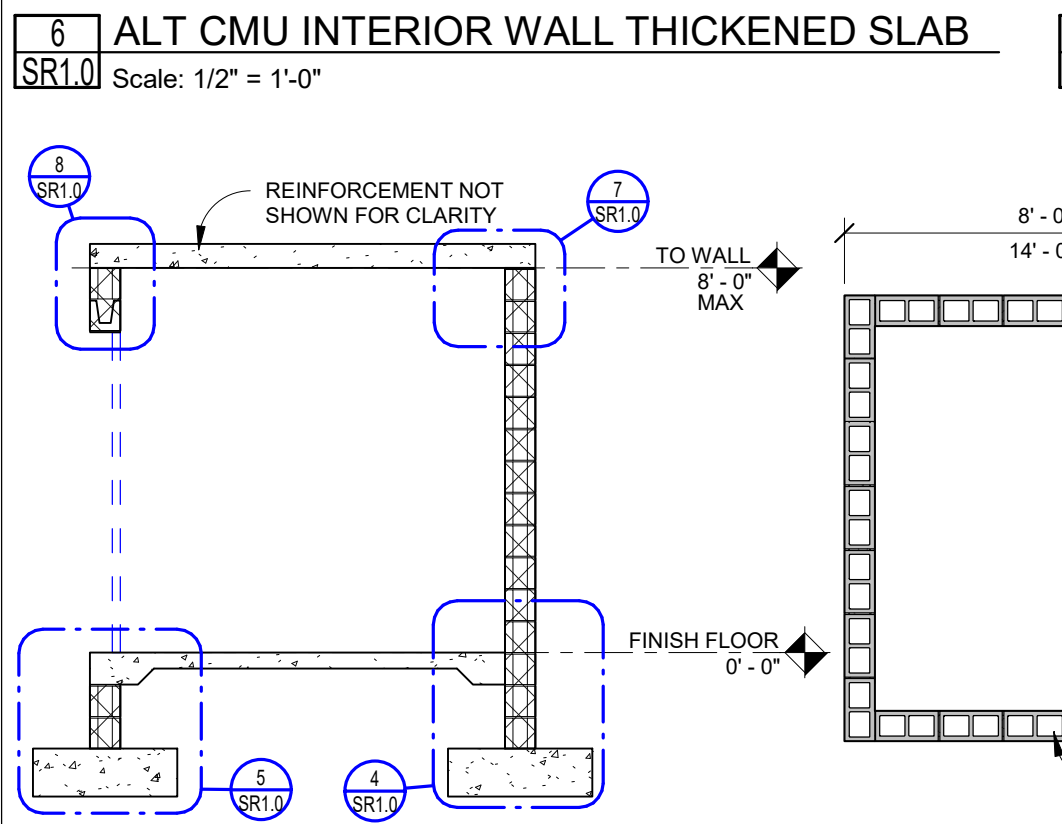
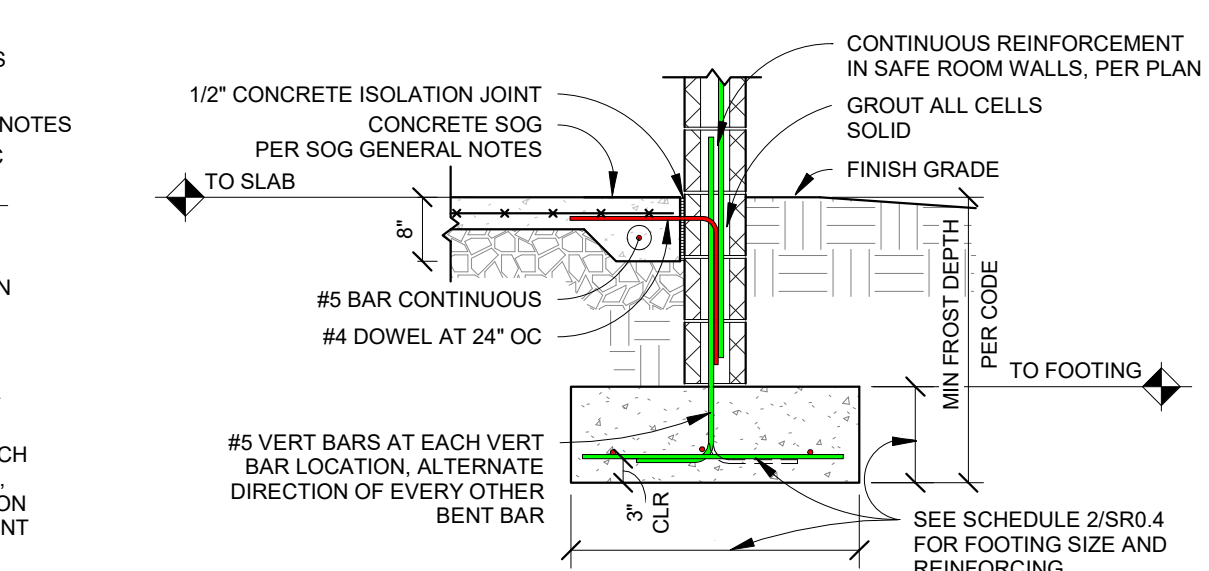
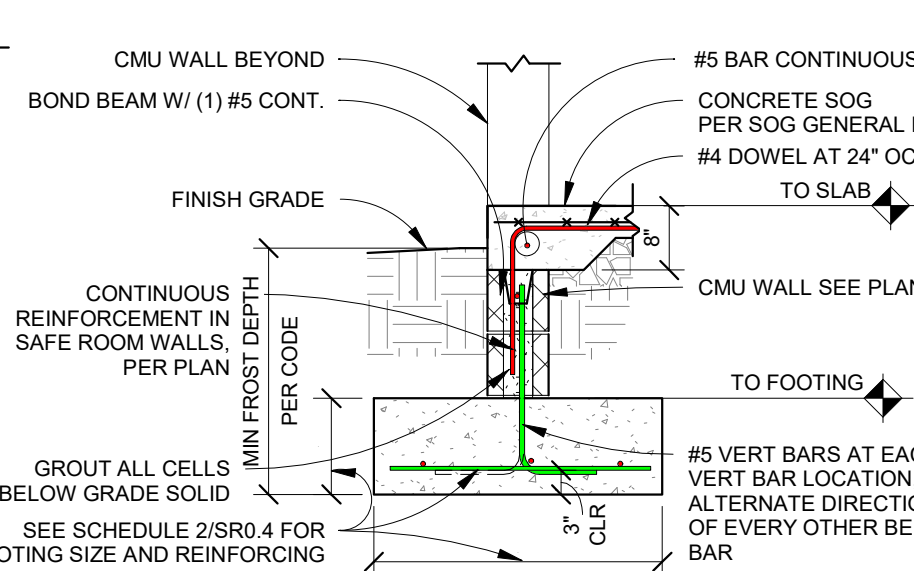
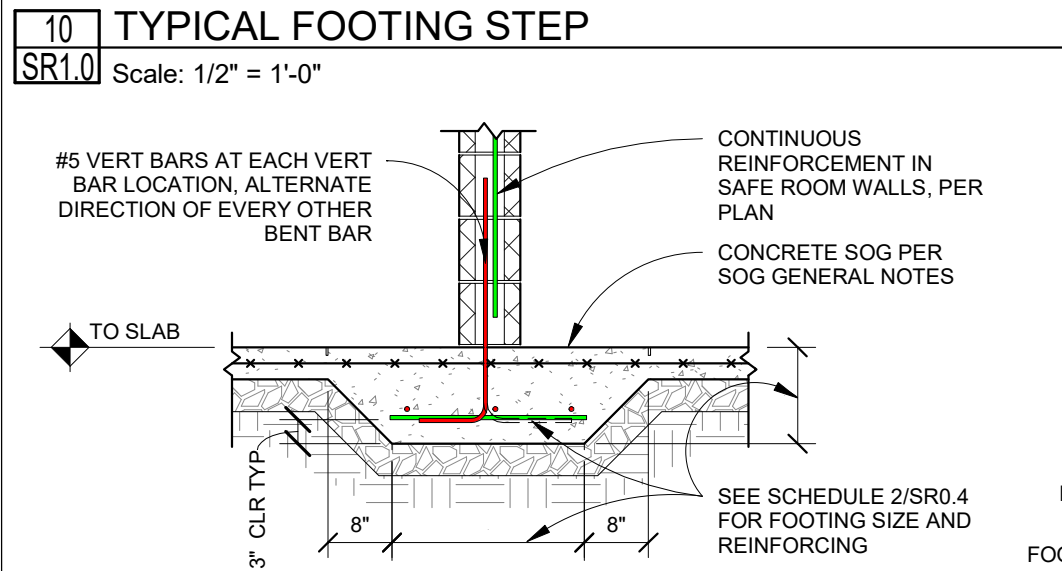
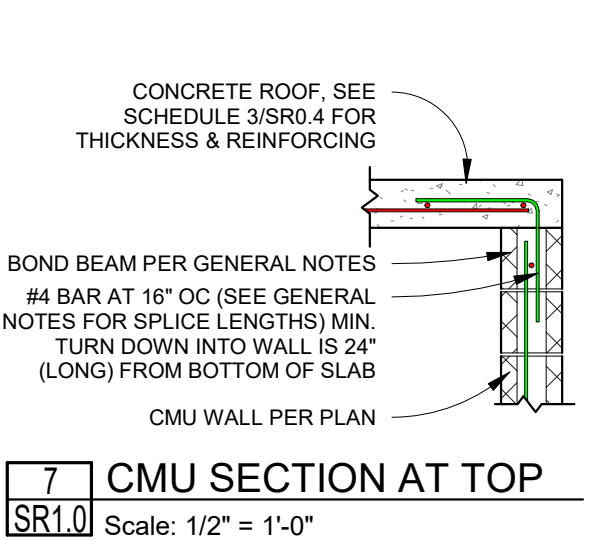
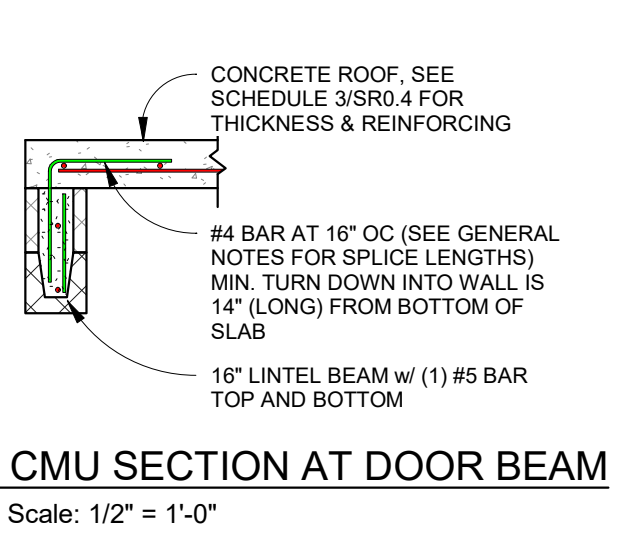
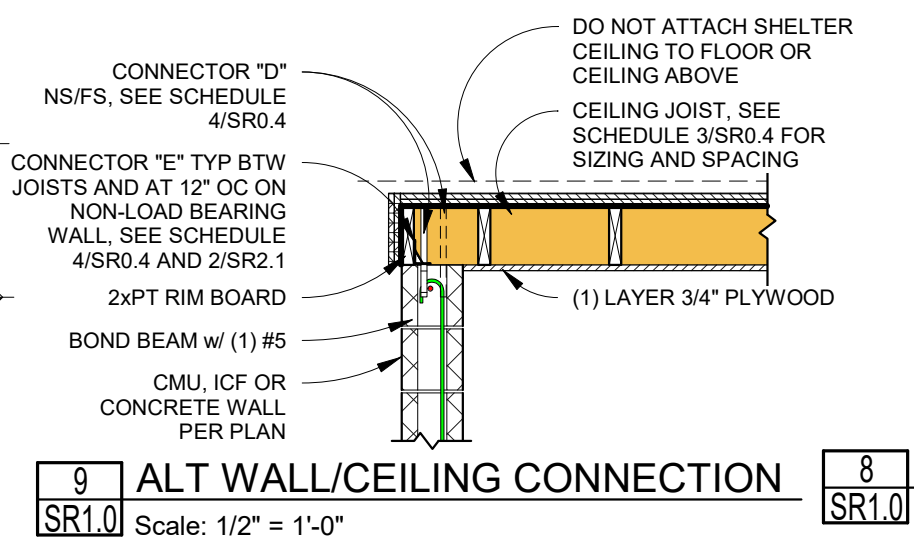
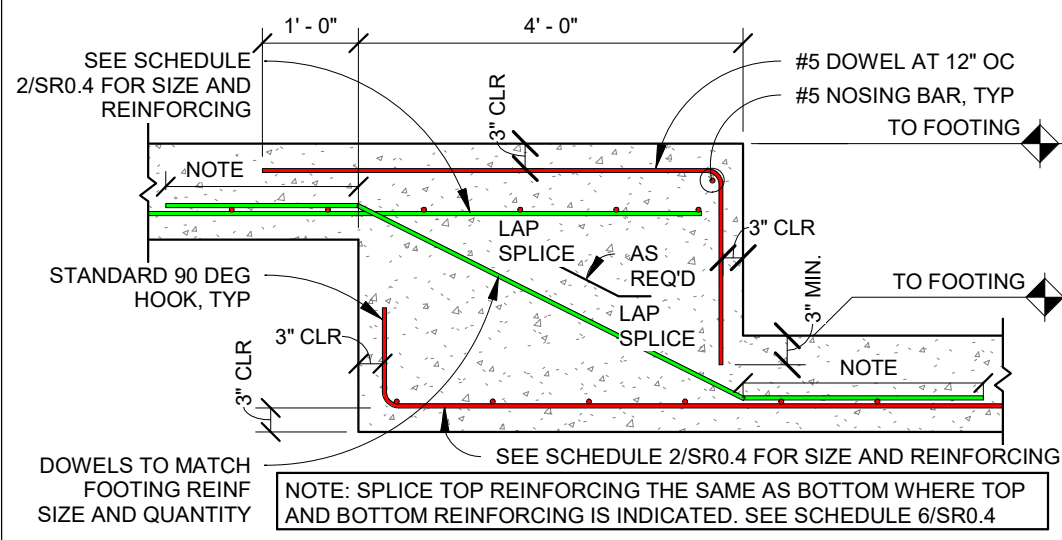

NOTE:
 1. FINISHED FLOOR ELEVATION SHALL BE LESS THAN 5 FT ABOVE LOWEST FINISHED ADJACENT GRADE ELEVATION
 2. SEE SR0.4 FOR SCHEDULES
 3. MINIMUM FROST DEPTH PER CODE, BUT NOT LESS THAN 2'-6"

3 CMU CROSS SECTION
 SR1.0 Scale: 1/4" = 1'-0"

2 CMU FLOOR PLAN
 SR1.0 Scale: 1/4" = 1'-0"

1 CMU FOUNDATION PLAN
 SR1.0 Scale: 1/4" = 1'-0"

FEMA P-320 (2021)
 Second Printing of Design Plans

SHEET TITLE:
 CMU SAFE ROOM PLANS AND DETAILS

DRAWING NO: **SR1.0** Sheet: 6 of 12

DATE: OCTOBER 2021

Copyright © 2021

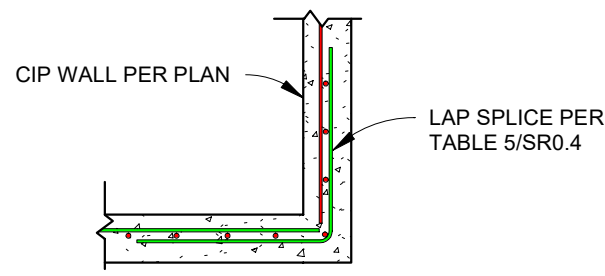

9 CONC SECTION AT CORNER

SR1.1 Scale: 1/2" = 1'-0"

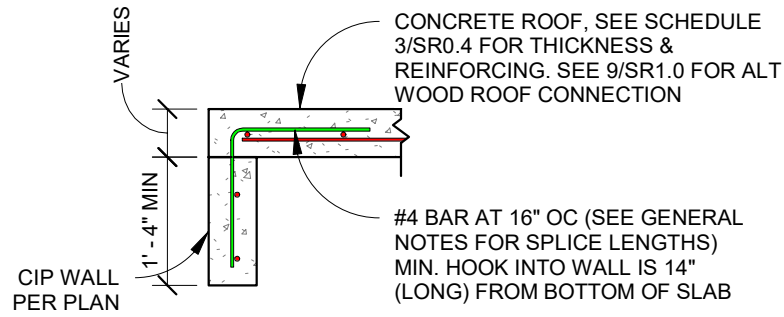

8 CONC SECTION AT DOOR BEAM

SR1.1 Scale: 1/2" = 1'-0"

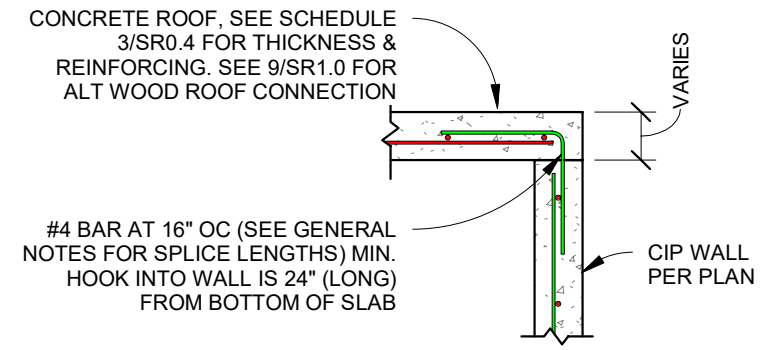

7 CONC SECTION AT TOP

SR1.1 Scale: 1/2" = 1'-0"

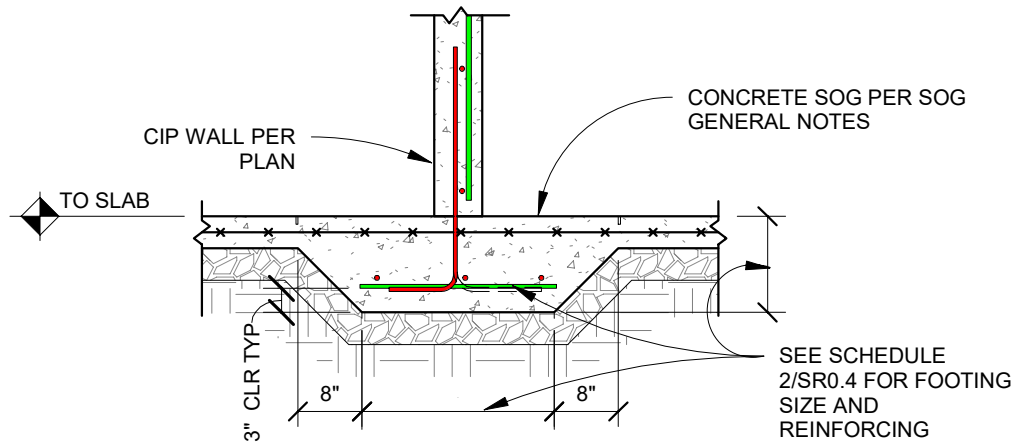

6 ALT CONC INTERIOR WALL THICKENED SLAB

SR1.1 Scale: 1/2" = 1'-0"

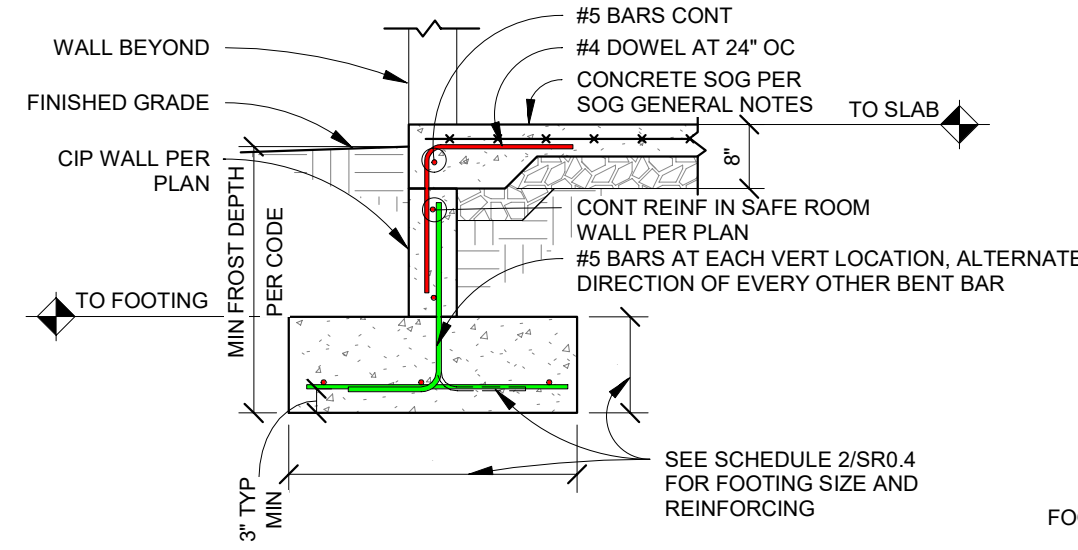

5 CONC EXTERIOR WALL FOUNDATION AT DOOR

SR1.1 Scale: 1/2" = 1'-0"

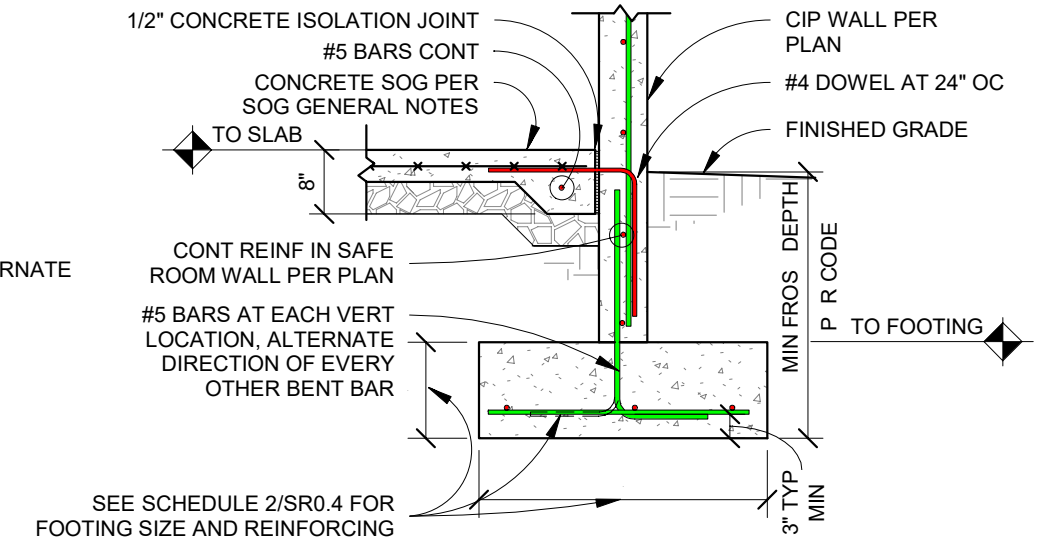

4 CONC EXTERIOR WALL FOUNDATION

SR1.1 Scale: 1/2" = 1'-0"

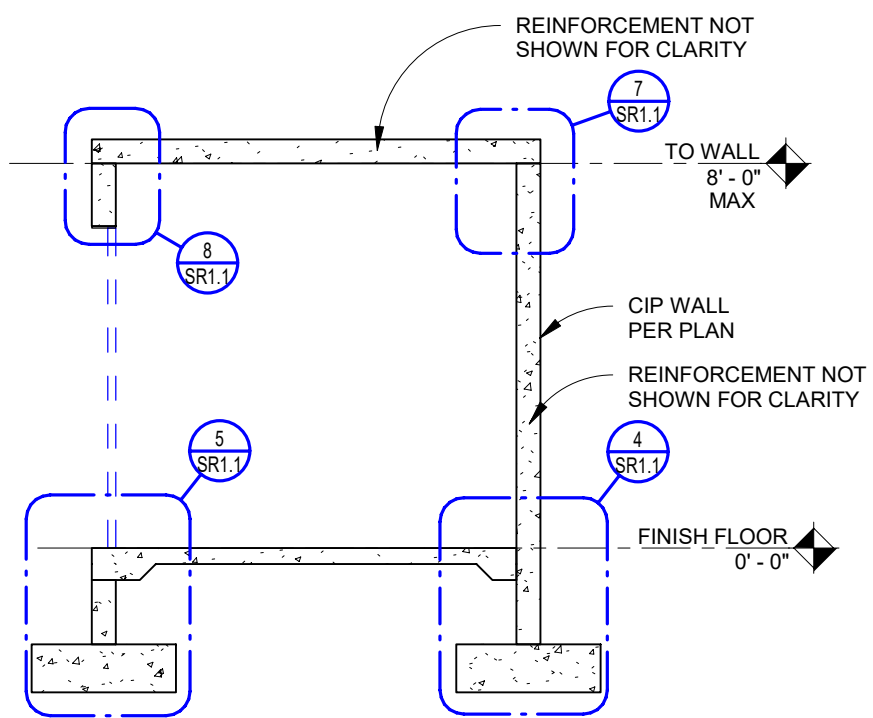

3 CONCRETE CROSS SECTION

SR1.1 Scale: 1/4" = 1'-0"

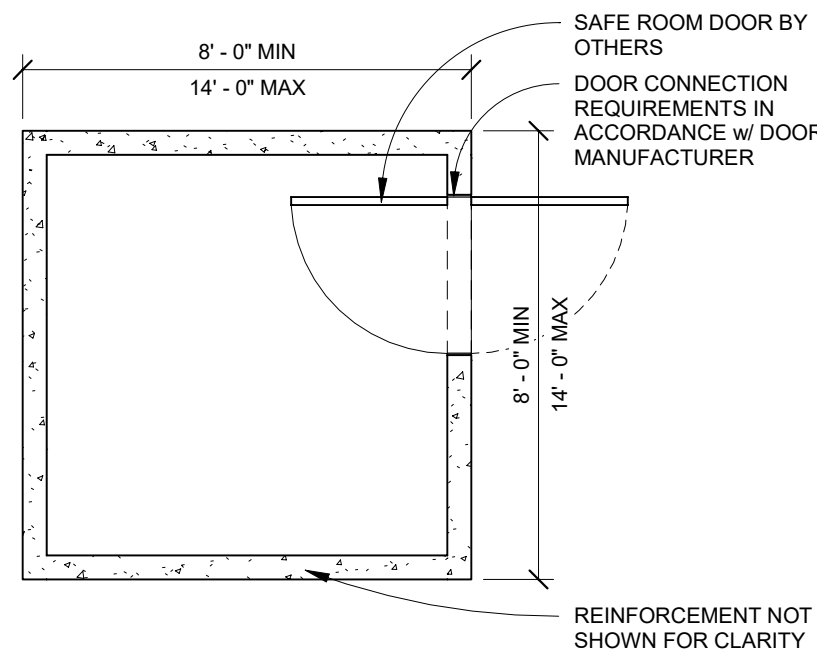

2 CONCRETE FLOOR PLAN

SR1.1 Scale: 1/4" = 1'-0"

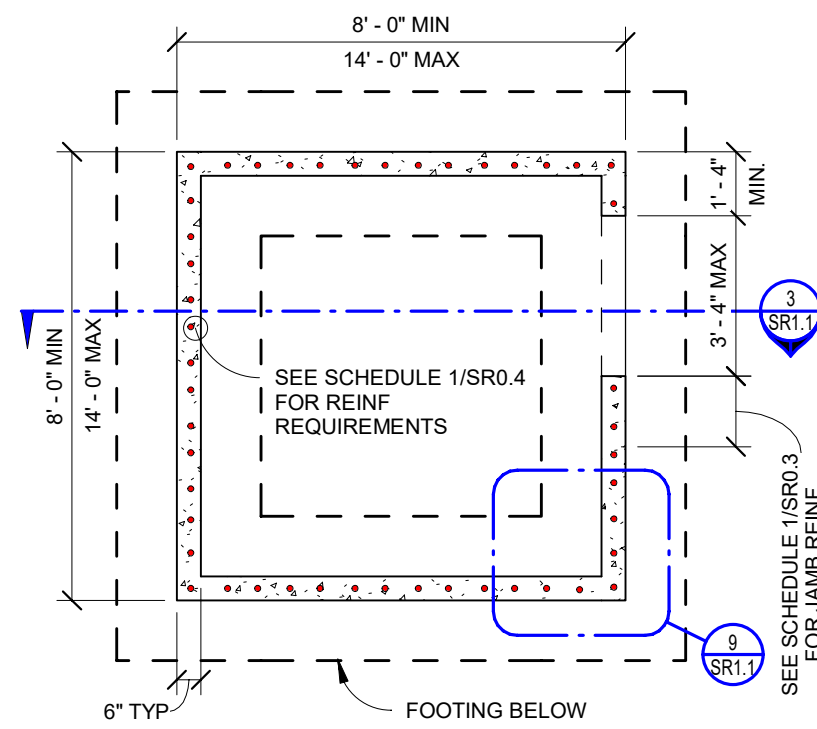

1 CONCRETE FOUNDATION PLAN

SR1.1 Scale: 1/4" = 1'-0"

NOTE:
 1. FINISHED FLOOR ELEVATION SHALL BE LESS THAN 5 FT ABOVE LOWEST FINISHED ADJACENT GRADE ELEVATION
 2. SEE SR0.4 FOR SCHEDULES
 3. MINIMUM FROST DEPTH PER CODE, BUT NOT LESS THAN 2'-6"

FEMA P-320 (2021)
 Second Printing of Design Plans

SHEET TITLE:
 CONCRETE SAFE ROOM PLANS AND DETAILS

DRAWING NO: **SR1.1** Sheet: 7 of 12

DATE: OCTOBER 2021 Copyright © 2021

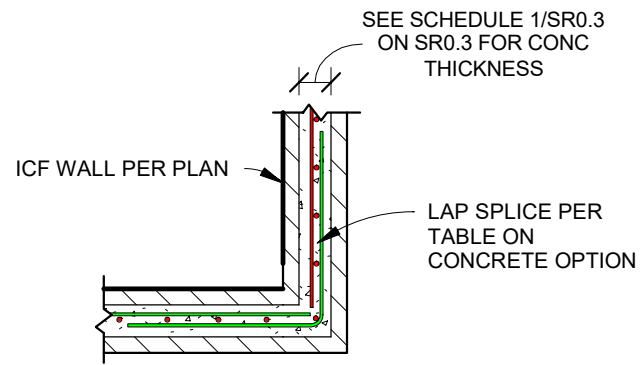

9 ICF CORNER DETAIL

SR1.2 Scale: 1/2" = 1'-0"

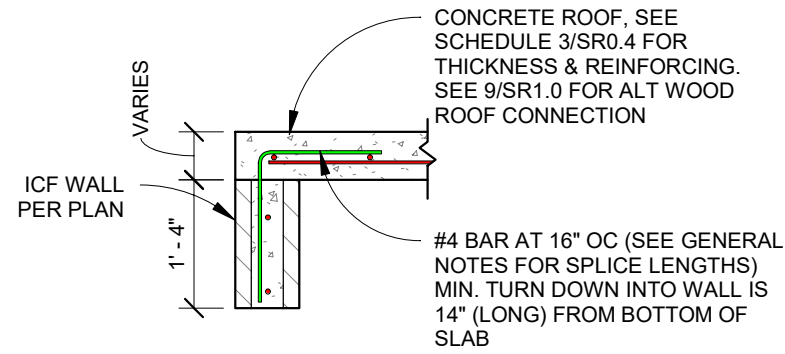

8 ICF SECTION AT DOOR BEAM

SR1.2 Scale: 1/2" = 1'-0"

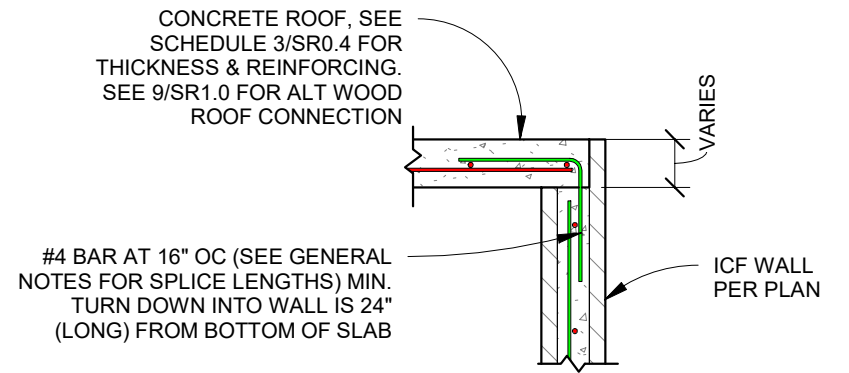

7 ICF SECTION AT TOP

SR1.2 Scale: 1/2" = 1'-0"

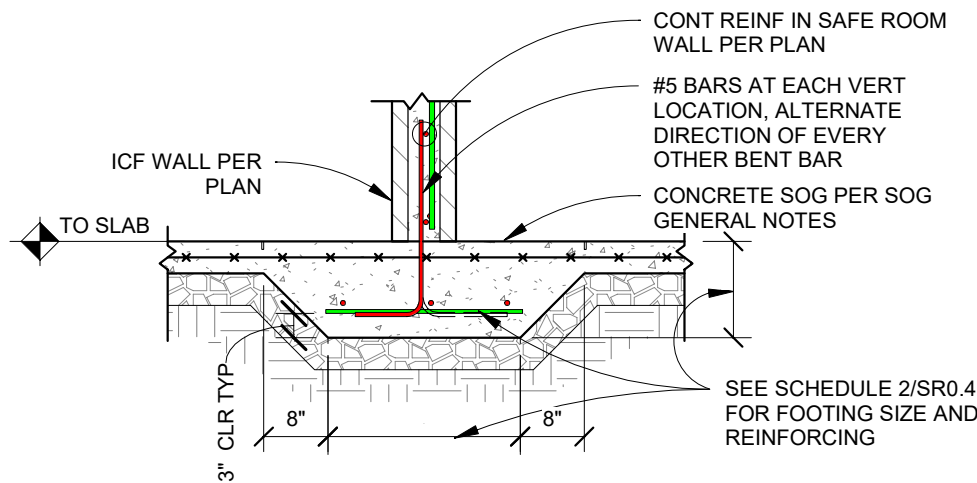

6 ALT ICF INTERIOR WALL THICKENED SLAB

SR1.2 Scale: 1/2" = 1'-0"

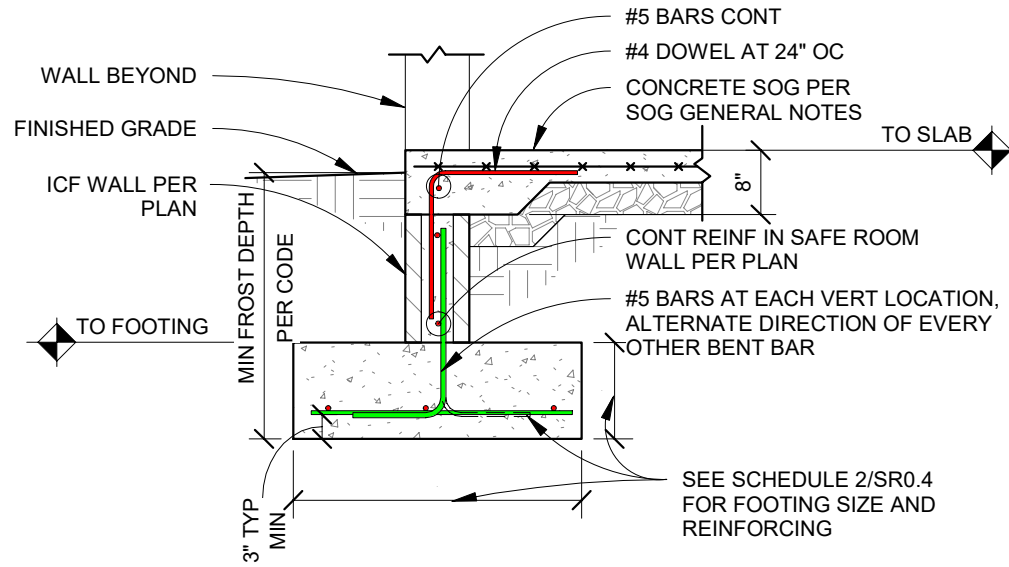

5 ICF EXTERIOR WALL FOUNDATION AT DOOR

SR1.2 Scale: 1/2" = 1'-0"

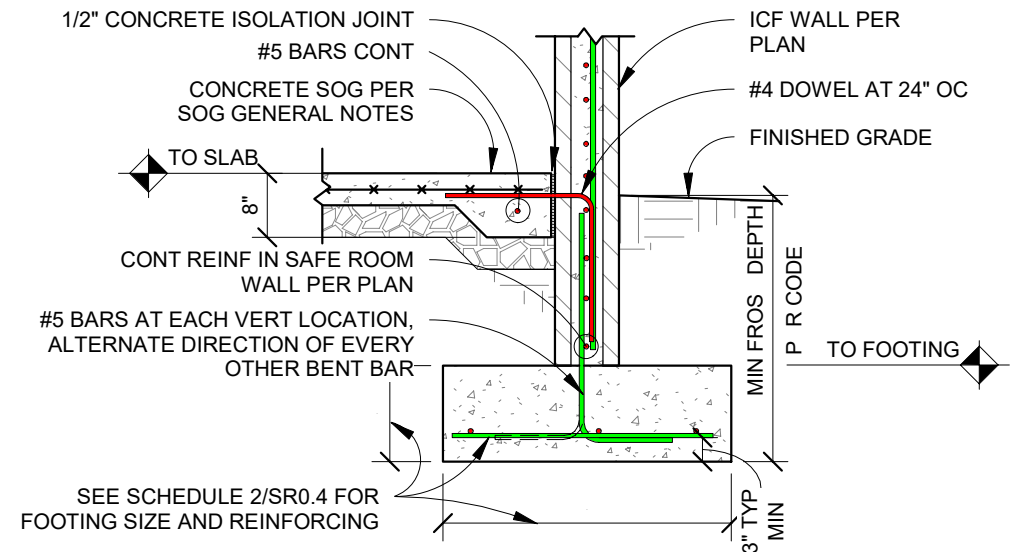

4 ICF EXTERIOR WALL FOUNDATION

SR1.2 Scale: 1/2" = 1'-0"

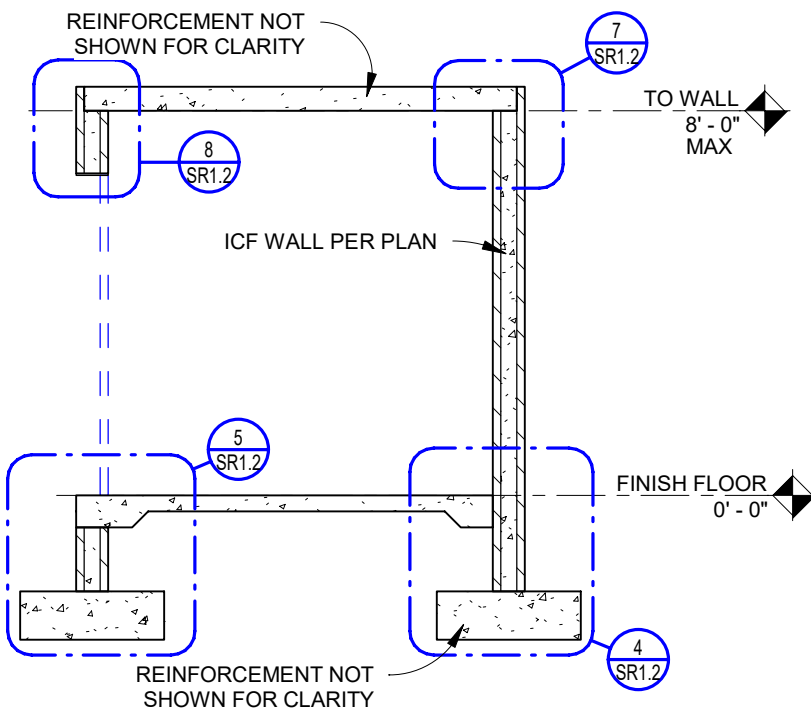

3 ICF CROSS SECTION

SR1.2 Scale: 1/4" = 1'-0"

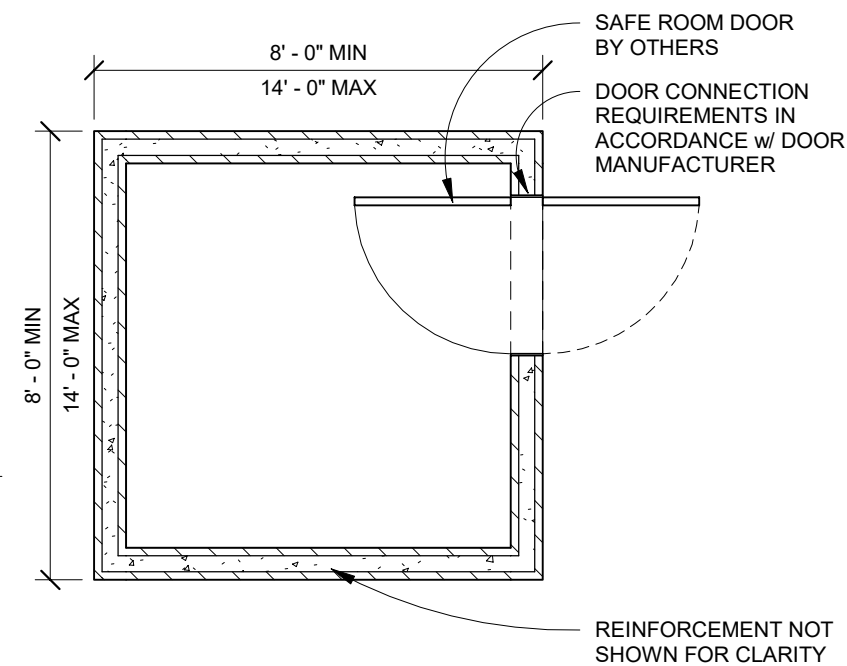

2 ICF FLOOR PLAN

SR1.2 Scale: 1/4" = 1'-0"

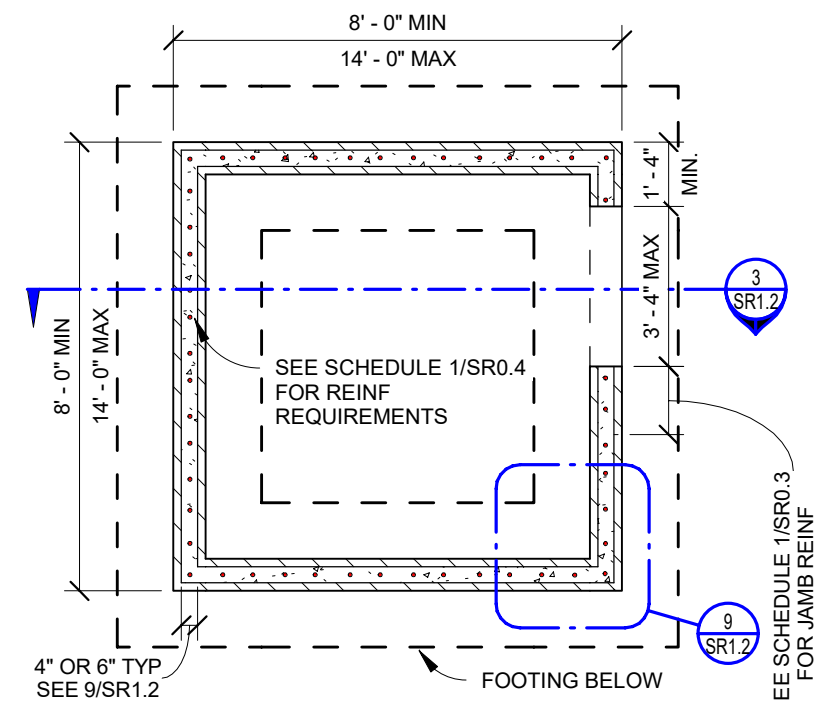

1 ICF FOUNDATION PLAN

SR1.2 Scale: 1/4" = 1'-0"

- NOTE:
1. FINISHED FLOOR ELEVATION SHALL BE LESS THAN 5 FT ABOVE LOWEST FINISHED ADJACENT GRADE ELEVATION
 2. SEE SR0.4 FOR SCHEDULES
 3. MINIMUM FROST DEPTH PER CODE, BUT NOT LESS THAN 2'-6"

FEMA P-320 (2021)
Second Printing of Design Plans

SHEET TITLE:
ICF SAFE ROOM PLANS AND DETAILS

DRAWING NO: SR1.2 Sheet: 8 of 12

DATE: OCTOBER 2021

Copyright © 2021

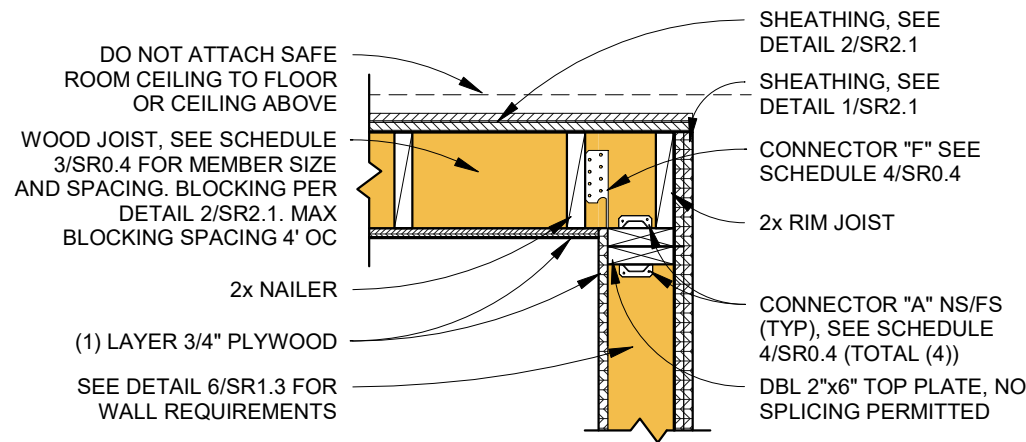

9 WOOD CEILING ATTACHMENT

SR1.3 Scale: 3/4" = 1'-0"

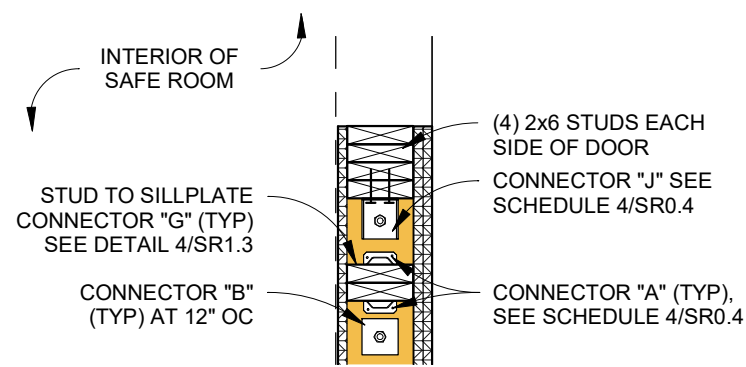

8 WOOD WALL CORNER AT DOOR PLAN

SR1.3 Scale: 3/4" = 1'-0"

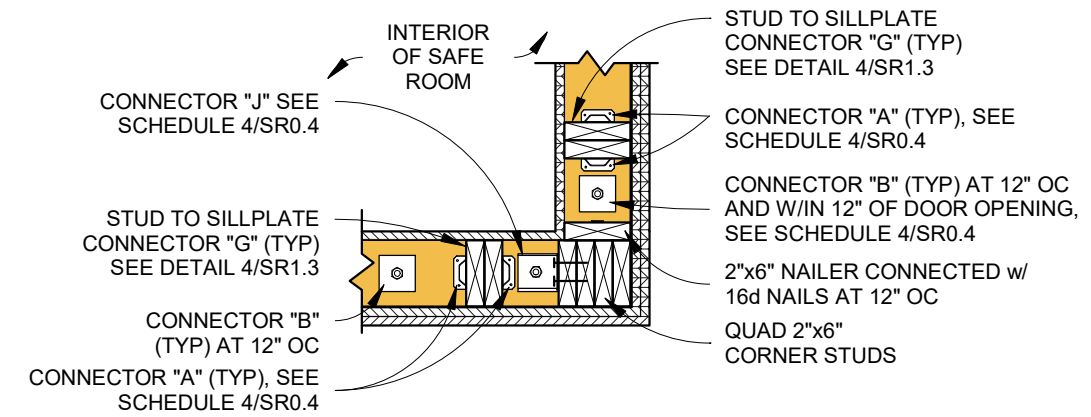

7 WOOD WALL CORNER PLAN

SR1.3 Scale: 3/4" = 1'-0"

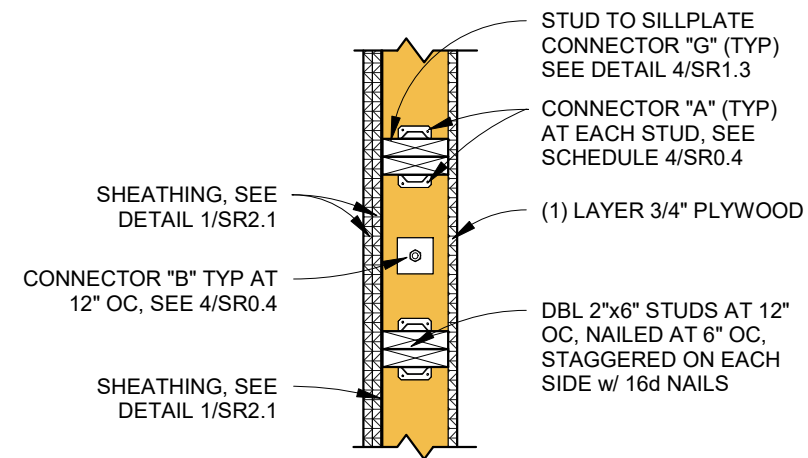

6 WOOD WALL BASE PLAN VIEW

SR1.3 Scale: 3/4" = 1'-0"

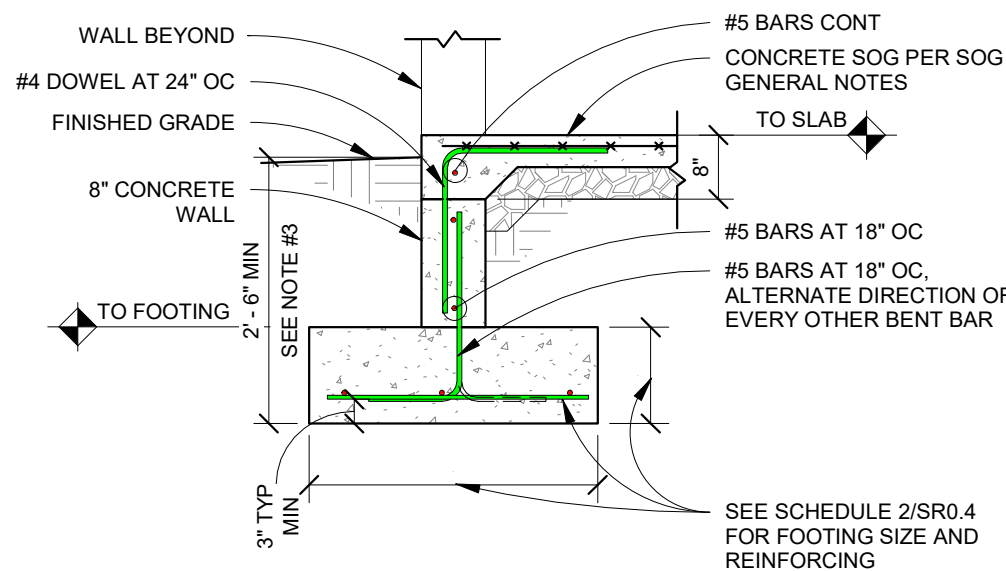

5 WOOD EXTERIOR WALL FOUNDATION AT DOOR

SR1.3 Scale: 1/2" = 1'-0"

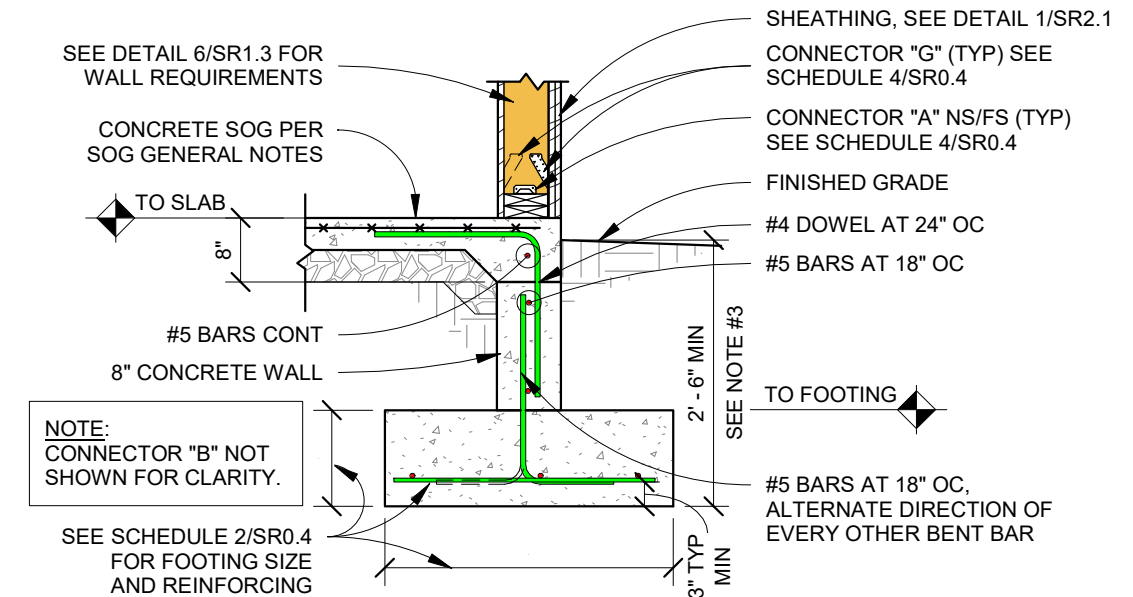

4 WOOD EXTERIOR WALL FOUNDATION

SR1.3 Scale: 1/2" = 1'-0"

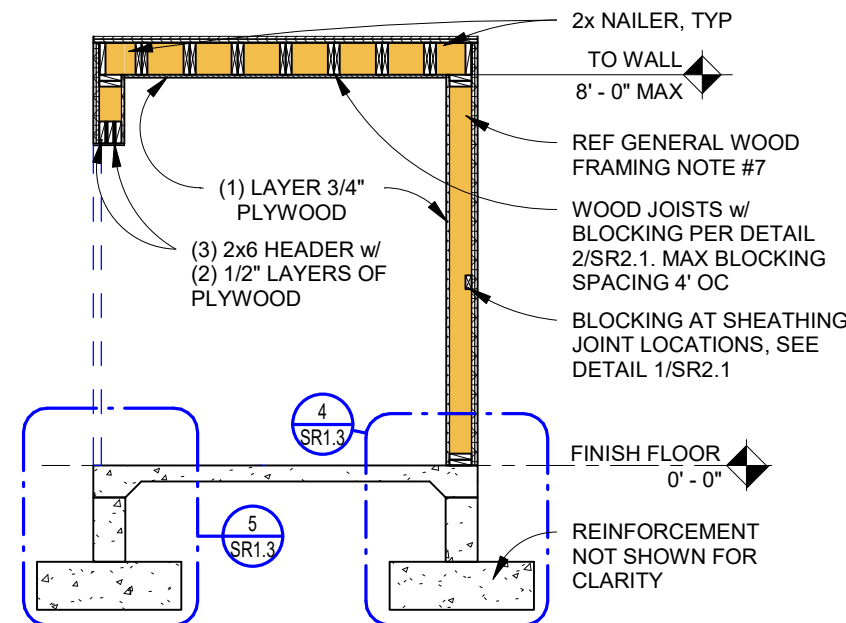

3 WOOD CROSS SECTION

SR1.3 Scale: 1/4" = 1'-0"

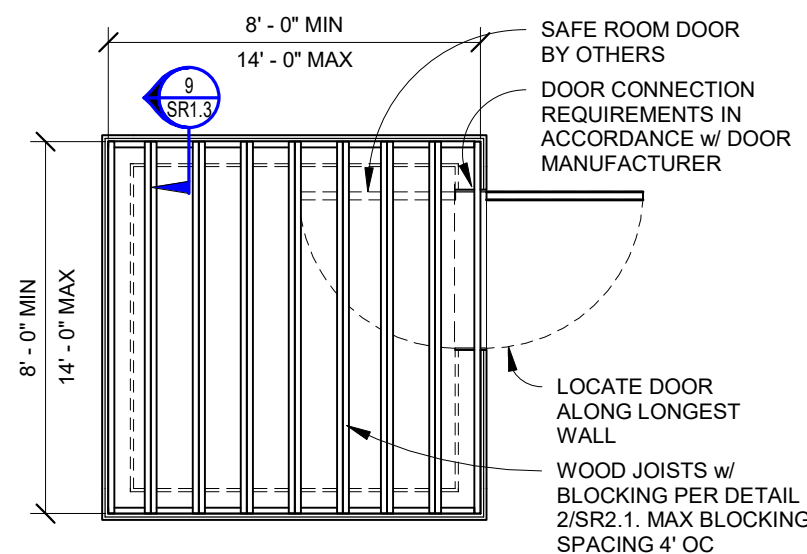

2 WOOD FRAMING PLAN

SR1.3 Scale: 1/4" = 1'-0"

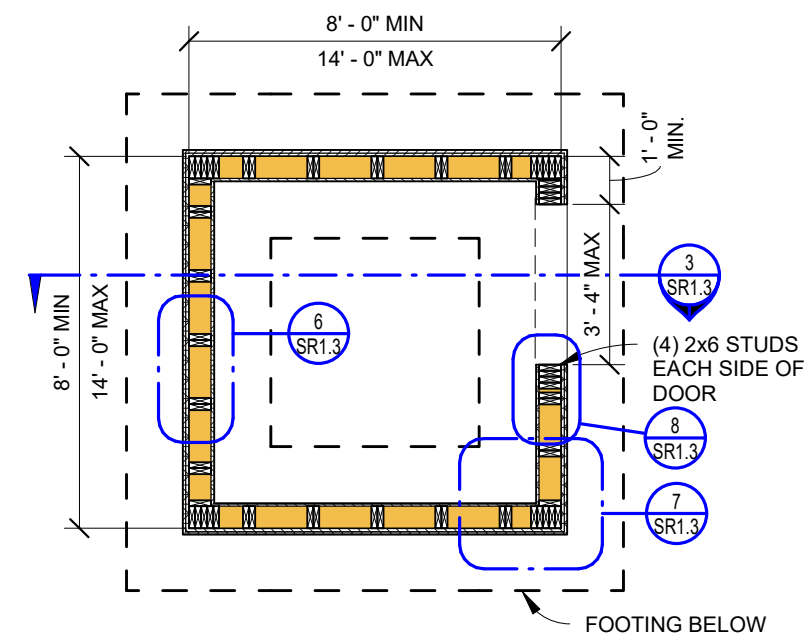

1 WOOD FRAME FOUNDATION PLAN

SR1.3 Scale: 1/4" = 1'-0"

NOTE:
 1. FINISHED FLOOR ELEVATION SHALL BE LESS THAN 5 FT ABOVE LOWEST FINISHED ADJACENT GRADE ELEVATION
 2. SEE SR0.4 FOR SCHEDULES
 3. MINIMUM FROST DEPTH PER CODE, BUT NOT LESS THAN 2'-6"

FEMA P-320 (2021)
 Second Printing of Design Plans

SHEET TITLE:
 WOOD FRAME SAFE ROOM PLANS AND DETAILS

DRAWING NO: **SR1.3** Sheet: 9 of 12

DATE: OCTOBER 2021

Copyright © 2021

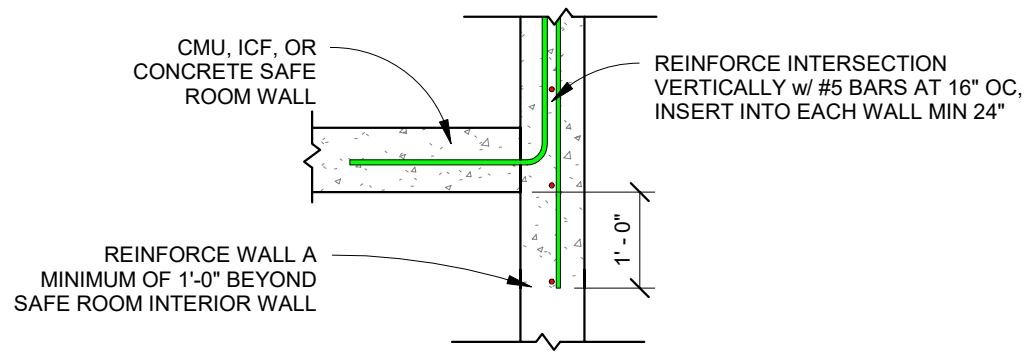

5 ALTERNATIVE CMU SAFE ROOM TO FOUNDATION WALL

SR1.4 Scale: 1/2" = 1'-0"

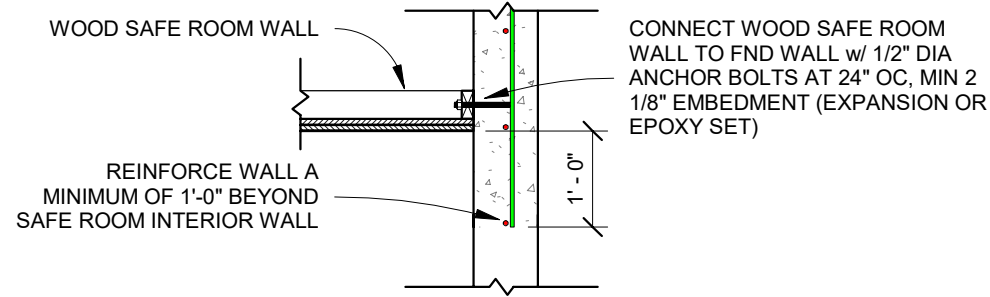

4 ALTERNATIVE WOOD SAFE ROOM TO FOUNDATION WALL

SR1.4 Scale: 1/2" = 1'-0"

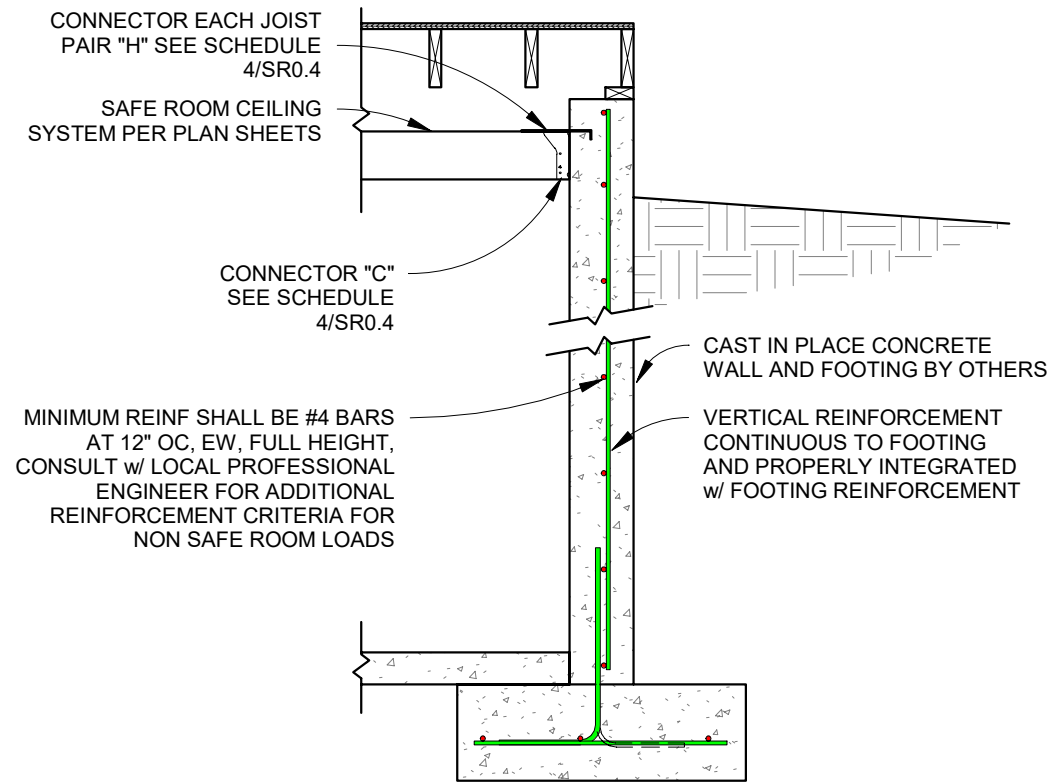

3 ALTERNATIVE CIP FOUNDATION ELEVATION

SR1.4 Scale: 1/2" = 1'-0"

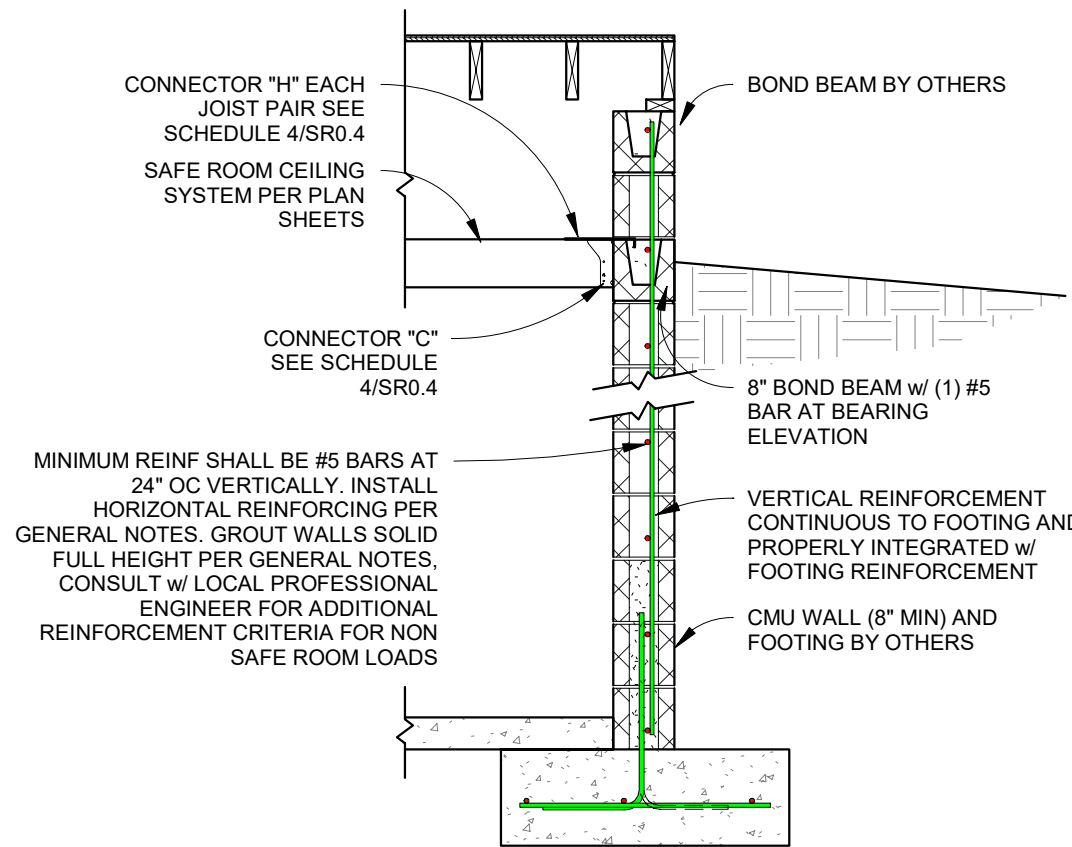

2 ALTERNATIVE CMU FOUNDATION ELEVATION

SR1.4 Scale: 1/2" = 1'-0"

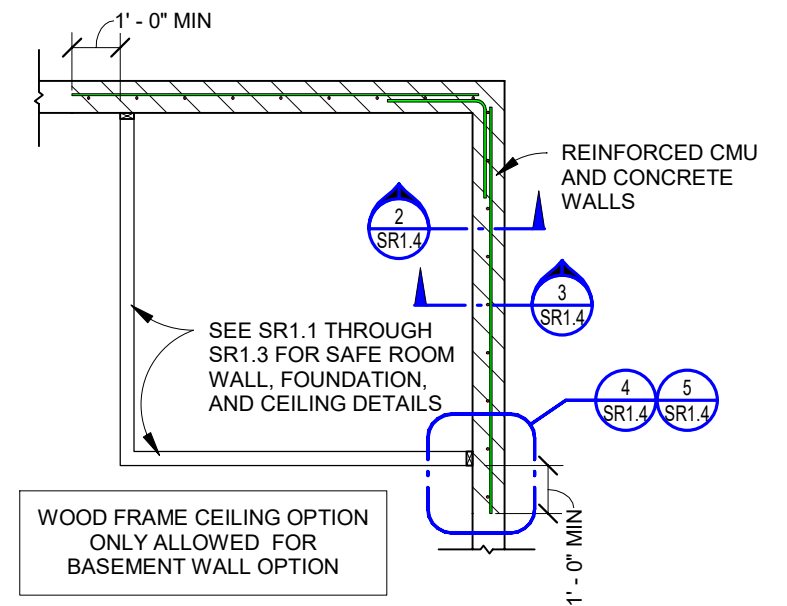

1 CORNER SAFEROOM PARTIAL PLAN

SR1.4 Scale: 1/4" = 1'-0"

FEMA P-320 (2021) Second Printing of Design Plans	
SHEET TITLE: DETAILS FOR SAFE ROOMS THAT USE BASEMENT WALLS	
DRAWING NO: SR1.4	Sheet: 10 of 12
DATE: OCTOBER 2021	
Copyright © 2021	

FOR CMU, ICF, AND CONCRETE WALLS ONLY. INSTALL CONNECTOR "E" BTW EACH JOIST AND AT 12" OC ON NON-LOAD BEARING WALL

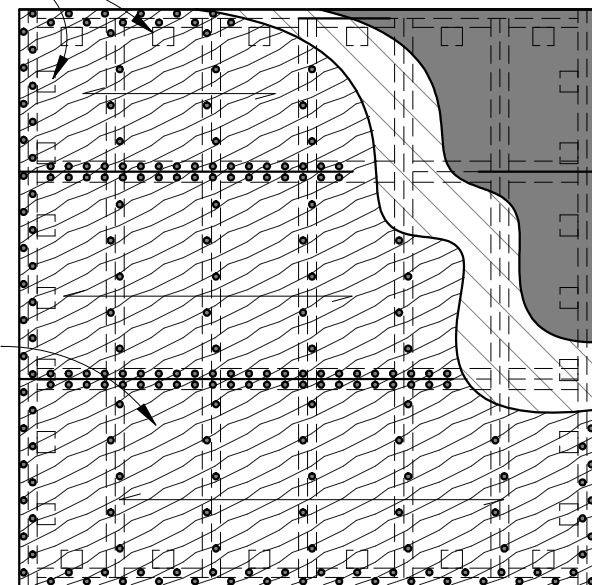

3RD LAYER

2ND LAYER = 3/4" PLYWOOD, MINIMALLY SECURED w/ 1/4" x 1 1/2" SELF-TAPPING SCREWS OR DRILL AND SECURE w/ #6 x 1 1/2" WOOD DECK SCREWS OR 8d NAILS TO HOLD IN PLACE

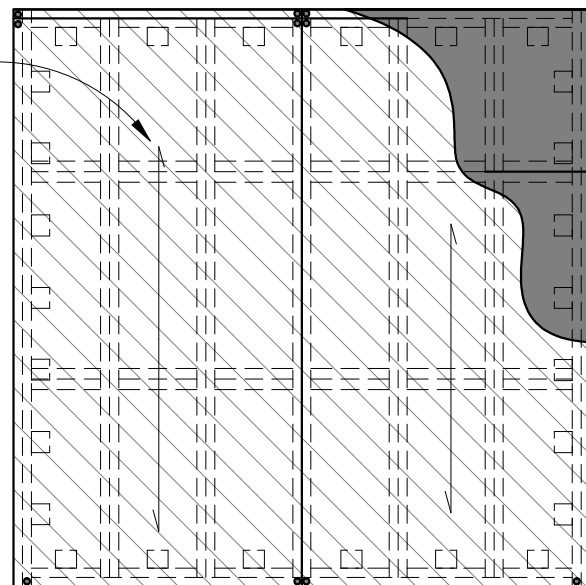

2ND LAYER

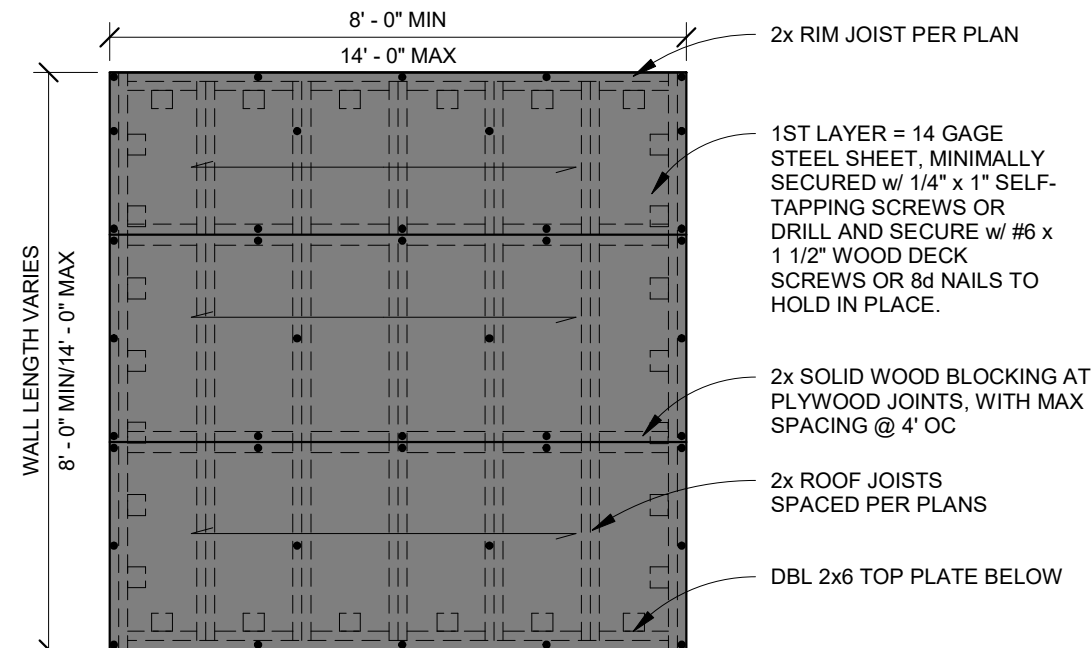

1ST LAYER

PLYWOOD SHEATHING AND STEEL SHEET ATTACHMENT PATTERN FOR PROTECTION LAYERS ON EXTERIOR SIDE OF SAFE ROOM

2 ROOF
SR2.1 Scale: 3/8" = 1'-0"

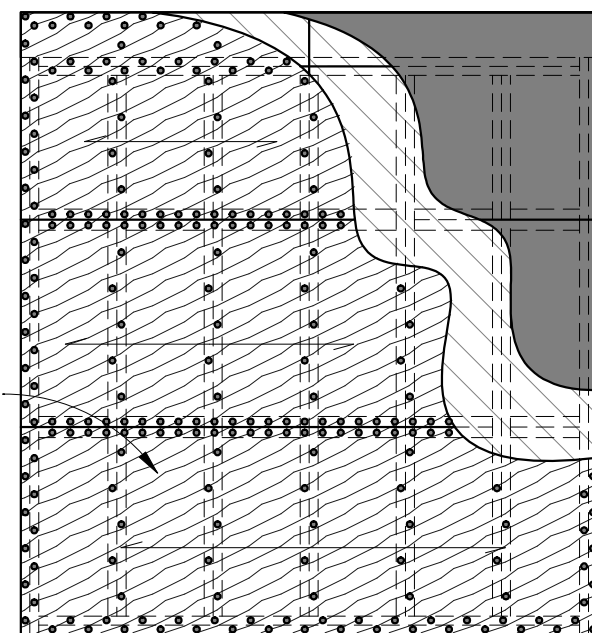

3RD LAYER

2ND LAYER = 3/4" PLYWOOD, MINIMALLY SECURED w/ 1/4" x 1 1/2" SELF-TAPPING SCREWS OR DRILL AND SECURE w/ #6 x 1 1/2" WOOD DECK SCREWS OR 8d NAILS TO HOLD IN PLACE.

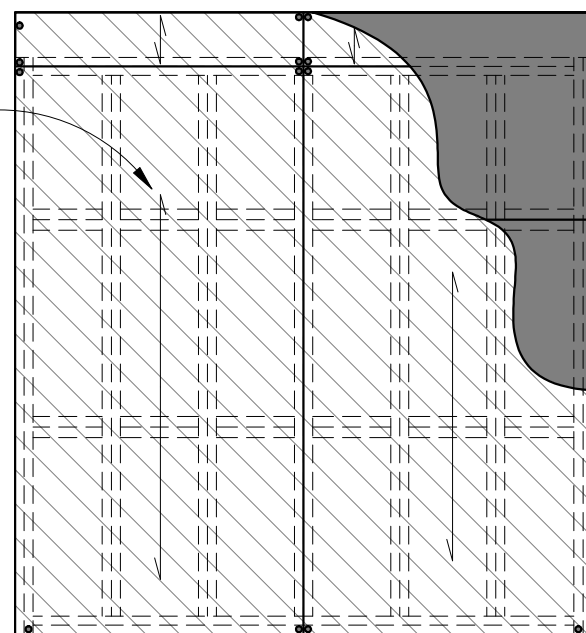

2ND LAYER

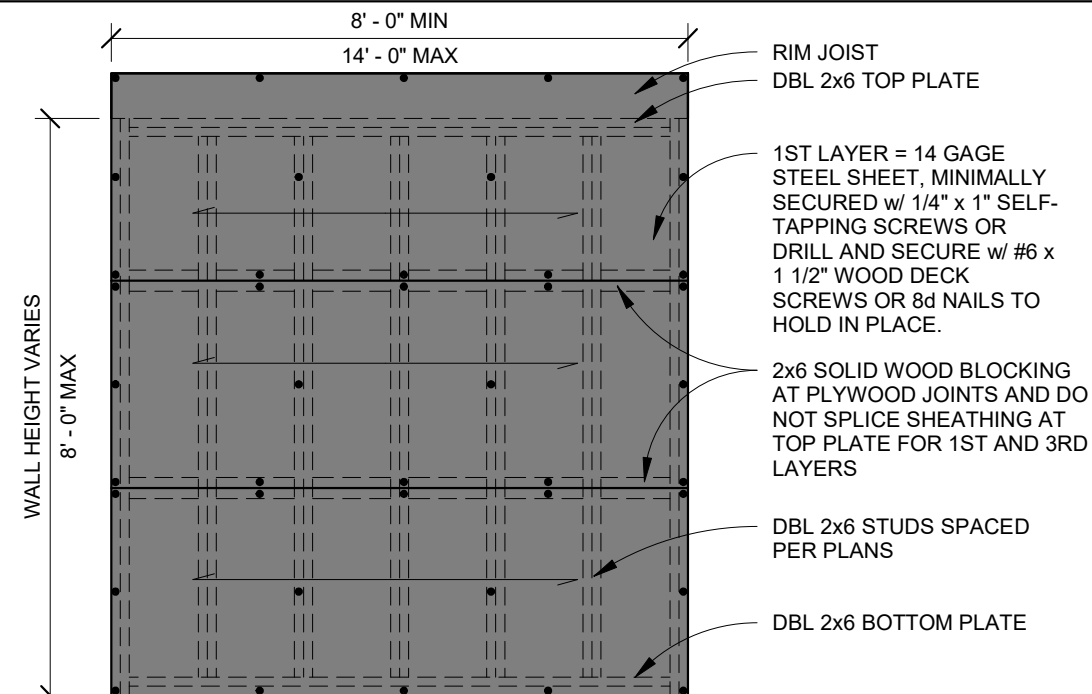

1ST LAYER

PLYWOOD SHEATHING AND STEEL SHEET ATTACHMENT PATTERN FOR PROTECTION LAYERS ON EXTERIOR SIDE OF SAFE ROOM

1 WALL
SR2.1 Scale: 3/8" = 1'-0"

- SHEATHING LEGEND**
- 3rd LAYER EXTERIOR PLYWOOD SHEATHING
 - 2nd LAYER PLYWOOD SHEATHING
 - 1st LAYER EXTERIOR STEEL SHEET

SHEATHING AND SHEET ATTACHMENT SCHEDULE			
PANEL LENGTH	16d NAILS	#8x3" WOOD DECK SCREWS	1/4"x3" SELF TAPPING SCREWS
3'-6" TO 5'-0"	2" OC AT EDGES 6" OC IN FIELD	2" OC AT EDGES 6" OC IN FIELD	3" OC AT EDGES 6" OC IN FIELD
5'-1" TO 7'-0"	3" OC AT EDGES 6" OC IN FIELD	3" OC AT EDGES 6" OC IN FIELD	4" OC AT EDGES 6" OC IN FIELD
7'-1" TO 14'-0"	4" OC AT EDGES 6" OC IN FIELD	4" OC AT EDGES 6" OC IN FIELD	6" OC AT EDGES 6" OC IN FIELD

NOTE:
FOR PRE-DRILLED OPTION, ONLY PRE-DRILL THROUGH SHEATHING, DO NOT PRE-DRILL BASE MATERIAL

- NOTE:
1. SHEATHING/SHEET ATTACHMENT VARIES BASED ON WALL LENGTH. SEE ATTACHMENT SCHEDULE FOR PROPER SPACING. PROTECTION LAYERS ARE TO BE INSTALLED ALTERNATING THE LONG AXIS OF THE MATERIAL FROM HORIZONTAL TO VERTICAL.
 2. MINIMUM UNBROKEN WALL LENGTH IS 3' - 6".
 3. EXCEPTION: SECOND LAYER OF DETAIL 1/SR2.1 MAY REQUIRE UPPER SHEATHING PIECE WIDTH TO BE 7", 8-3/4", OR 10-3/4" DEPENDING ON JOIST DEPTH.

FEMA P-320 (2021)
Second Printing of Design Plans

SHEET TITLE:
SAFE ROOM SHEATHING REQUIREMENTS

DRAWING NO: SR2.1 Sheet: 11 of 12

DATE: OCTOBER 2021

Copyright © 2021

RESIDENTIAL TORNADO SAFE ROOM DOOR PRESSURES			
NOMINAL DOOR PANEL SIZE	DOOR ASSEMBLY EFFECTIVE AREA (SF)	ZONE 5 MAX PRESSURE (PSF)	ZONE 4 MAX PRESSURE (PSF)
2'-6" x 6'-8"	18.56	-235	-204
2'-8" x 6'-8"	19.71	-233	-203
3'-0" x 6'-8"	21.99	-231	-202
2'-6" x 7'-0"	19.47	-234	-203
2'-8" x 7'-0"	20.66	-233	-203
3'-0" x 7'-0"	23.06	-230	-202

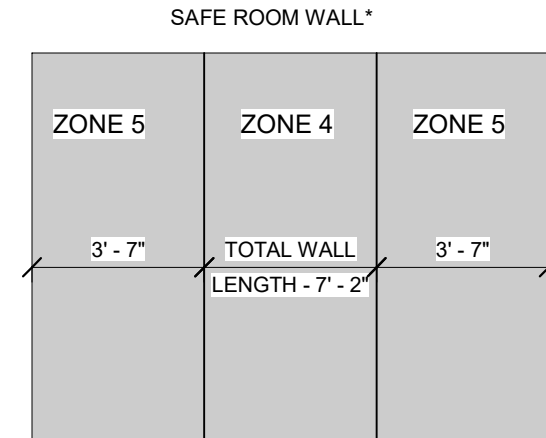

* ZONE LENGTHS BASED ON 8' - 0" WALL HEIGHT AND WOOD FRAME ROOF. LOWER MEAN ROOF HEIGHT REDUCES ZONE 5 LENGTH SLIGHTLY.

2 DOOR PRESSURE TABLE

SR2.2 Scale: 1/4" = 1'-0"

RESIDENTIAL TORNADO SAFE ROOM NATURAL VENTILATION		
TORNADO SAFE ROOM OCCUPANCY	NATURAL VENTILATION AREA REQUIRED (INCHES SQUARED)	MINIMUM NUMBER OF PIPE VENTS PER DETAIL 1/SR2.2
1	4*	2
2	4**	2
3	6**	2
4	8**	3
5	10**	4
6	12**	4
7	14**	5
8	16**	6
9	18**	6
10	20**	7
11	22**	8
12	24**	8
13	26**	9
14	28**	9
15	30**	10
16	32**	11

*PER ICC 500-20 SECTION 702.4.1.1. EXCEPTION, AIR INTAKE OPENING(S) MUST BE INSTALLED A MINIMUM OF 72" ABOVE SAFE ROOM FLOOR. WHEN INSTALLED ONLY IN UPPER PORTION, EXCEPTION REQUIRES 4 SQUARE INCHES PER OCCUPANT

**NATURAL VENTILATION AREA PER ICC 500-20 SECTION 702.4 AND ASSUMES AIR INTAKE OPENINGS ARE DISTRIBUTED BETWEEN THE UPPER AND LOWER PORTIONS OF SAFE ROOM AS SPECIFIED THEREIN; AREA AND RESULTING NUMBER OF VENTS REQUIRED MUST BE DOUBLED WHEN AIR INTAKE OPENINGS ARE INSTALLED EXCLUSIVELY IN THE UPPER PORTION AS PROVIDED PER EXCEPTION IN SECTION 702.4.1.1.

CONSULT W/ LOCAL BUILDING OFFICIAL AND REFER TO ICC 500-20 SECTION 306.6 FOR OPENING PROTECTIVE REQUIREMENTS

WARNING: TO PREVENT INJURY FROM SMALL WIND-BORNE DEBRIS, SAFE ROOM OCCUPANTS SHOULD AVOID AREAS DIRECTLY BENEATH DOWN-FACING VENTILATION PIPE ELBOWS.

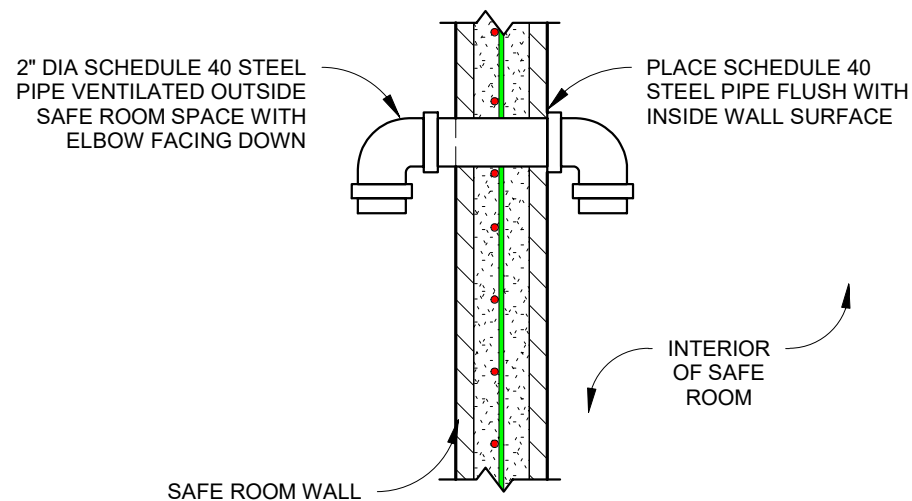

1 NATURAL VENTILATION DETAIL FOR EXTERIOR WALL

SR2.2 Scale: 3/4" = 1'-0"

FEMA P-320 (2021)
Second Printing of Design Plans

SHEET TITLE:
SAFE ROOM OPENING REQUIREMENTS

DRAWING NO: SR2.2 Sheet: 12 of 12

DATE: OCTOBER 2021

Copyright © 2021

Errata

Date: October 28, 2021

Issuing Office: Federal Emergency Management Agency

Name of Document: *Taking Shelter from the Storm: Building a Safe Room for Your Home*

FEMA Publication No.: FEMA P-320 (2021)

These errata change only the “FEMA P-320 SAFE ROOM DESIGN PLANS,” which are included with FEMA P-320, *Taking Shelter from the Storm*. Therefore, the publication shall remain “FEMA P-320, March 2021, *Fifth Edition*,” with only the “FEMA P-320 SAFE ROOM DESIGN PLANS” now shown as “(2021, Second Printing).” The following changes were made to the “FEMA P-320 SAFE ROOM DESIGN PLANS” after its initial publication on the Federal Emergency Management Agency website:

Location	Incorrect Values	Corrected Values
SR0.0, Title	FEMA P-320 SAFE ROOM DESIGN PLANS TAKING SHELTER FROM THE STORM: BUILDING A SAFE ROOM FOR YOUR HOME	FEMA P-320 SAFE ROOM DESIGN PLANS TAKING SHELTER FROM THE STORM: BUILDING A SAFE ROOM FOR YOUR HOME <u>Second Printing of Design Plans</u>
Title Block, All Sheets	FEMA P-320 (2021)	FEMA P-320 (2021) <u>Second Printing of Design Plans</u>
SR0.3, MASONRY GENERAL NOTES	2. CONCRETE MASONRY SHALL BE HOLLOW LOAD-BEARING CONCRETE MASONRY UNITS CONFORMING TO ASTM C90. ALL UNITS SHALL BE PLACED IN RUNNING BOND CONSTRUCTION WITH ALL VERTICAL CELLS IN ALIGNMENT EXCEPT AT DRY STACKED INFILL LOCATIONS.	2. CONCRETE MASONRY SHALL BE HOLLOW LOAD-BEARING CONCRETE MASONRY UNITS CONFORMING TO ASTM C90. ALL UNITS SHALL BE PLACED IN RUNNING BOND CONSTRUCTION WITH ALL VERTICAL CELLS IN ALIGNMENT EXCEPT AT DRY STACKED INFILL LOCATIONS.
SR0.3, MASONRY GENERAL NOTES	8. MASONRY GROUT SHALL BE IN ACCORDANCE WITH ASTM C476. GROUT EXCEPT FOR SELF-CONSOLIDATING GROUT SHALL HAVE A SLUMP BETWEEN 8 AND 11” WHEN MEASURED IN ACCORDANCE WITH ASTM C143. ALL CELLS IN CONCRETE MASONRY UNITS SHALL BE SOLID GROUTED. EXCEPTION: DRY-STACKED MASONRY FOR WOOD- FRAME INFILL OPTION.	8. MASONRY GROUT SHALL BE IN ACCORDANCE WITH ASTM C476. GROUT EXCEPT FOR SELF-CONSOLIDATING GROUT SHALL HAVE A SLUMP BETWEEN 8 AND 11” WHEN MEASURED IN ACCORDANCE WITH ASTM C143. ALL CELLS IN CONCRETE MASONRY UNITS SHALL BE SOLID GROUTED. EXCEPTION: DRY-STACKED MASONRY FOR WOOD- FRAME INFILL OPTION.

Location	Incorrect Values	Corrected Values
SR0.4, Schedule 1	<ul style="list-style-type: none"> • <i>HORIZONTAL (HEADER)</i> • <i>16" BOND BEAM w/ (1) #5 bar top & bottom</i> 	<ul style="list-style-type: none"> • <i>HORIZONTAL (HEADER)</i> <u><i>(LINTEL)</i></u> • <i>16" BOND BEAM w/ (1) #5 bar top & bottom</i> <u><i>8" LINTEL w/ (1) #5 bar</i></u> <p><i>Under Table Heading, 'OPENING REINFORCEMENT', changed 'HORIZONTAL (HEADER)' to 'HORIZONTAL (LINTEL)' and changed the HORIZONTAL (LINTEL) specification for 8" CMU wall from '16" BOND BEAM w/ (1) #5 bar top & bottom' to '8" LINTEL w/ (1) #5 bar'.</i></p>
SR0.4, Schedule 1	*AT 1'-4" WALL END, THIRD BAR MAY BE SET IN ADJACENT WALL	<ul style="list-style-type: none"> • <i>*AT 1'-4" WALL END, THIRD BAR MAY BE SET IN ADJACENT WALL</i> • <u><i>4. WHERE DISTANCE BETWEEN DOOR OPENING AND OUTER WALL CORNER IS LESS THAN 2', EXTEND LINTEL REINFORCEMENT AROUND CORNER & SET THIRD VERTICAL BAR IN ADJACENT WALL.</i></u> <p><i>Deleted note indicated by asterisk & added new NOTE 4</i></p>
SR0.4, Schedule 1	2. REFERENCE SPLICE TABLE FOR EXTENSION OF HEADER REINFORCEMENT PAST OPENING	<p><i>2. REFERENCE SPLICE TABLE FOR EXTENSION OF HEADER REINFORCEMENT PAST OPENING. ALL LINTEL REINFORCING SHALL EXTEND 2 FEET PAST JAMBS.</i></p> <p><i>Modified NOTE 2</i></p>
SR0.4, Schedule 1	Reference 'Corrected Values' entry	<i>Modified NOTES column contents by adding '3' to bottom (3) 'WALL TYPE' rows & '4' to each row</i>
SR0.4, Schedule 2	Reference 'Corrected Values' entry	<i>"WOOD / CMU INFILL" row</i>

Location	Incorrect Values	Corrected Values
SR0.4, Schedule 4	CONNECTOR 'J', 'NOTES' CELL: BLANK	<ul style="list-style-type: none"> • <i>CONNECTOR 'J', 'NOTES' CELL: <u>SEE NOTE #5</u></i> • <i><u>5. WHERE DISTANCE FROM OUTER CORNER OF FRAMED WALL AND DOOR OPENING IS 16" OR GREATER, INSTALL CONNECTOR J AT BOTH DOOR OPENING SUPPORTS AND EACH WALL CORNER. WHERE LESS THAN 16", INSTALL STUDS AS SHOWN IN DETAIL 1/SR1.3 WITH CONNECTORS J AT OPPOSITE DOOR OPENING SUPPORT ONLY AND EACH WALL CORNER.</u></i> <p><i>Added Note #5</i></p>
SR1.0, SR1.1, SR1.2, SR1.3, Details 4 & 5	CONCRETE SOG PER GENERAL NOTES	CONCRETE SOG PER <u>SOG</u> GENERAL NOTES
SR1.3, Detail 7	<ul style="list-style-type: none"> • 2X6 NAILER CONNECTED W/ 16d NAILS AT 12" OC • CONNECTOR 'J' SEE SCHEDULE 4/SR0.4. (1) AT EACH CORNER, EACH SIDE OF DOOR OPENING 	<ul style="list-style-type: none"> • 2X6 NAILER CONNECTED W/ 16d NAILS AT 12" OC • 'CONNECTOR 'J' SEE SCHEDULE 4/SR0.4'. (1) AT EACH CORNER, EACH SIDE OF DOOR OPENING' <p><i>Deleted 2"x6" nailer (note and leader) from wall corner in Detail 7/SR1.3 to provide needed space for studs and wood connectors; Deleted second sentence from Connector J note.</i></p>
SR1.3, Detail 8	CONNECTOR 'J' SEE SCHEDULE 4/SR0.4. (1) AT EACH CORNER, EACH SIDE OF DOOR OPENING	CONNECTOR 'J' SEE SCHEDULE 4/SR0.4. (1) AT EACH CORNER, EACH SIDE OF DOOR OPENING'

Location	Incorrect Values	Corrected Values
SR2.1, Detail 2, 1ST LAYER	2x SOLID WOOD BLOCKING AT PLYWOOD JOINTS, WITH MAX SPACING AT 4" OC	2x SOLID WOOD BLOCKING AT PLYWOOD JOINTS, WITH MAX SPACING AT 4' ²² OC <i>Changed "4" to "4'" (inches to feet) on 1ST LAYER blocking specification</i>